

DCS DIGITAL COMBAT SIMULATOR

UH-1H **HUEY**



FLIGHT MANUAL

Bell
Helicopter
A Textron Company

OFFICIAL LICENSED PRODUCT
68-7213-35445



THE FIGHTER COLLECTION



Eagle Dynamics



Bell, UH-1H Huey, emblems, logos, and body designs are trademarks of Textron Innovations Inc. and are used under license by Sky Jet International LLC ©

TABLE OF CONTENTS

2.1.	GENERAL DESCRIPTION AND MISSION OVERVIEW.....	5
2.2.	PRIMARY SPECIFICATIONS UH-1H.....	6
2.3.	GENERAL ASSEMBLY DIAGRAM	8
2.4.	ENGINE AND RELATED SYSTEMS	10
2.5.	POWER TRAIN SYSTEM.....	17
2.6.	COCKPIT LAYOUT	21
4.1.	CYCLIC CONTROL SYSTEM.....	36
4.2.	COLLECTIVE CONTROL SYSTEM.....	38
4.3.	TAIL ROTOR CONTROL SYSTEM	39
4.4.	FORCE TRIM SYSTEM	39
5.1.	INSTRUMENT PANEL	44
5.2.	PEDESTAL CONTROL PANELS.....	64
5.3.	OVERHEAD CONSOLE	67
6.1.	HELICOPTER FUEL SYSTEM.....	70
6.2.	ELECTRICAL SYSTEM	72
6.3.	HYDRAULIC SYSTEM.....	77
6.4.	DE-ICE	78
6.5.	GAME AUTOPILOT	78
7.1.	RADIO COMMUNICATIONS EQUIPMENT	83
7.2.	RADIO NAVIGATION EQUIPMENT	89
8.1.	M23 ARMAMENT SUBSYSTEM.....	94
8.2.	XM93 ARMAMENT SUBSYSTEM.....	95
8.3.	M21 ARMAMENT SUBSYSTEM DESCRIPTION.....	96
8.4.	M21 ARMAMENT SUBSYSTEM PROCEDURES	102
8.5.	FLARE DISPENSER M130	106
8.6.	GUNNER ARTIFICIAL INTELLIGENCE (AI) CONTROL	108
9.1.	STARTING ENGINE	111
9.2.	TAKE-OFF AND HOVER.....	114
9.3.	CLIMB.....	123
9.4.	CRUISE	123
9.5.	DESCENT AND LANDING	124
9.6.	ENGINE SHUTDOWN	126
9.7.	AUTOROTATION. PRACTICAL PART	127
11.1.	SLING LOAD USAGE.....	140
11.2.	HELICOPTER ASSAULT (AIRLIFT DELIVERY).....	147
11.3.	MULTIPLAYER MISSIONS WITH MULTI-CREW	147



1

HELICOPTER HISTORY

1. HELICOPTER HISTORY

Note. This section is under construction

In our game you can carry out performances missions on model UH-1H.

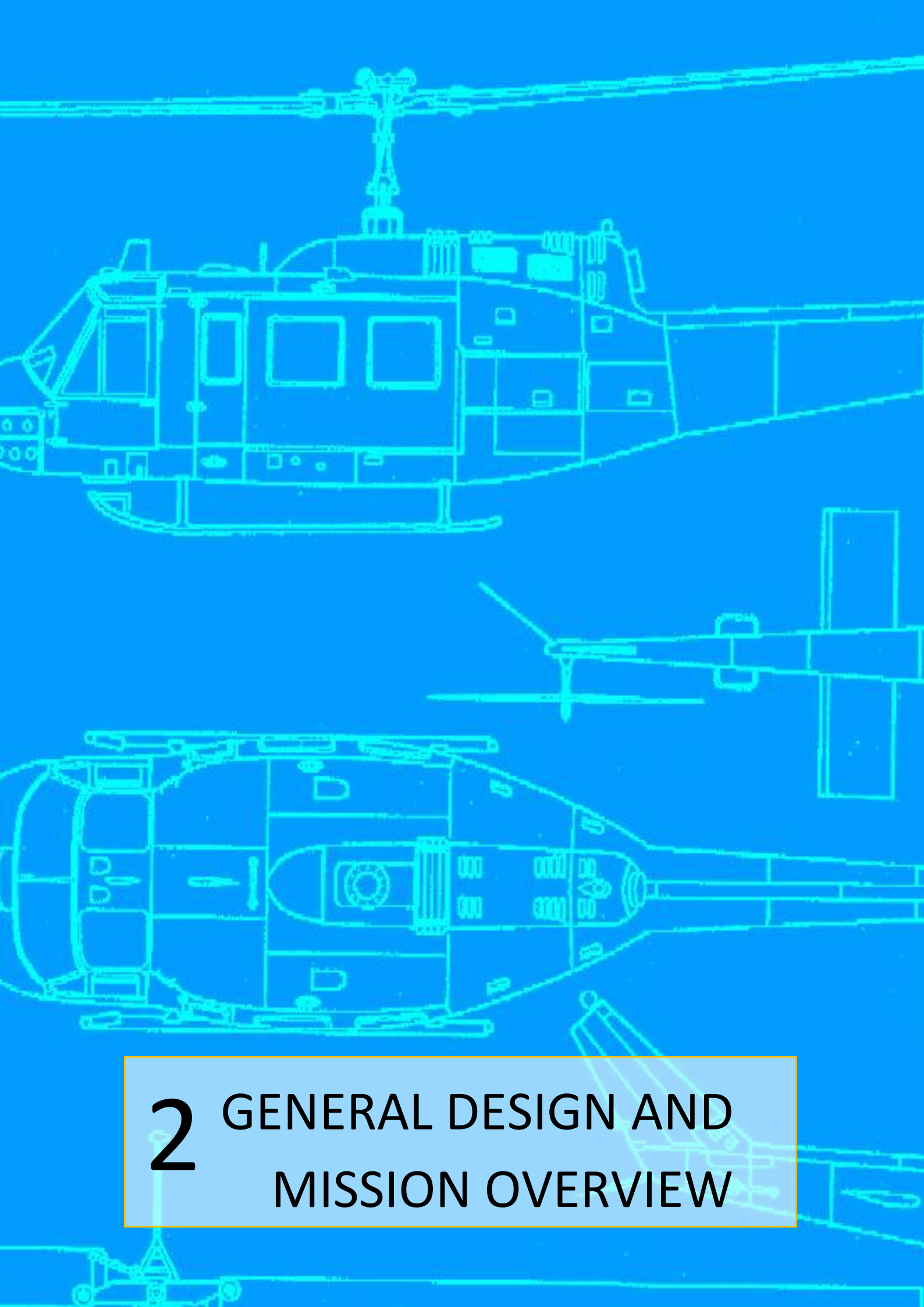

2

GENERAL DESIGN AND MISSION OVERVIEW

2. GENERAL DESIGN AND MISSION OVERVIEW

2.1. General Description and mission overview

The UH-1H is a single engine, single rotor helicopter. Primary mission capability of the helicopter is air movement of supplies and personnel. Secondary missions include SASO¹, air assault, and C2² operations under day, night, visual, and instrument conditions.

In DCS: UH-1H Huey, the helicopter can be operated in the following variants:

- a) Combat transport – delivery of troops and/or materiel. Up to 11 combat troops can be transported and deployed.
- b) Air assault – armed air assault employing a variety of weapon systems (see chapter 8).

The helicopter can be employed either from prepared airfields or Forward Area Rearming/Refueling Point (FARP) helipads.

The crew includes the pilot in the right-hand seat, copilot in the left-hand seat and one or two door gunners.

¹ SASO – stability and support operations – military activities during peacetime and conflict that do not necessarily involve armed clashes between two organized forces.

² C² – command and control

2.2. Primary specifications UH-1H

2.2.1. Specifications table

A. AIRCRAFT	UNIT	UH-1H
B. NORMAL CREW	per acft	2
C. OPERATIONAL CHARACTERISTICS		
(1) Max allowable gross	lbs / kg	9.500 / 4.309
(2) Basic weight	lbs / kg	5.914 / 2.683
(3) Useful load	lbs / kg	4.368 / 1.981
(4) Payload/Normal mission	lbs / kg	2.900 / 1.315
(5) Fuel capacity internal	lbs/gal // kg/l	1.358/204 // 616/770
(6) Fuel consumption rate	lbs/gal/h // kg/l/h	550/84 // 250/318
(7) Normal cruise speed	kts / km/h	90–120 / 160–220
(8) Endurance at cruise (Plus 30 min reserve)	hrs+min	2+15
(9) Grade of fuel	octane	JP 4/5
D. PASSENGER CAPACITY		
(1) Troops seats	ea	11
(2) Total capacity with crew	ea	13
(3) Litters and ambulatory	ea	13
E. EXTERNAL CARGO		
(1) Maximum recommended	lbs / kg	4.000 / 1.814
(2) Rescue hoist capacity	lbs / kg	300 / 136
F. DIMENSIONS		
(1) Length — fuselage	ft-in / m	40'7" / 12,38
(2) Length — blades unfolded	ft-in / m	57'1" / 17,41
(3) Length — blades folded	ft-in / m	NA
(4) Width — blades folded	ft-in / m	8'7" / 2,62
(5) Width — tread	ft-in / m	8'7" / 2,62
(6) Height — extreme	ft-in / m	14'6" / 4,42
(7) Diameter — main rotor	ft-in / m	48'3" / 14,71
(8) Diameter — tail rotor	ft-in / m	8'6" / 2,59
(9) Wing span	ft-in / m	NA
G. CARGO DOOR		
(1) Dimensions — width x height	ft-in / m	74"x48" / 1,88x1,22
(2) Location — side of fuselage	side of fus.	left & right
H. CARGO COMPARTMENT		
(1) Floor — above ground	in / m	24 / 0,61
(2) Usable length	in / m	92 / 2,34
(3) Floor width	in / m	96 / 2,44
(4) Height (clear of obstructions)	in / m	49 / 1,24
(5) Maximum cargo space	cu ft / cu m	220 / 6,24
I. WEAPONS		
		M21

Note. The composite rotor blades provide a 6% improvement in the UH-1H's hovering capability and a 5 to 8 percent reduction in fuel flow in forward flight.

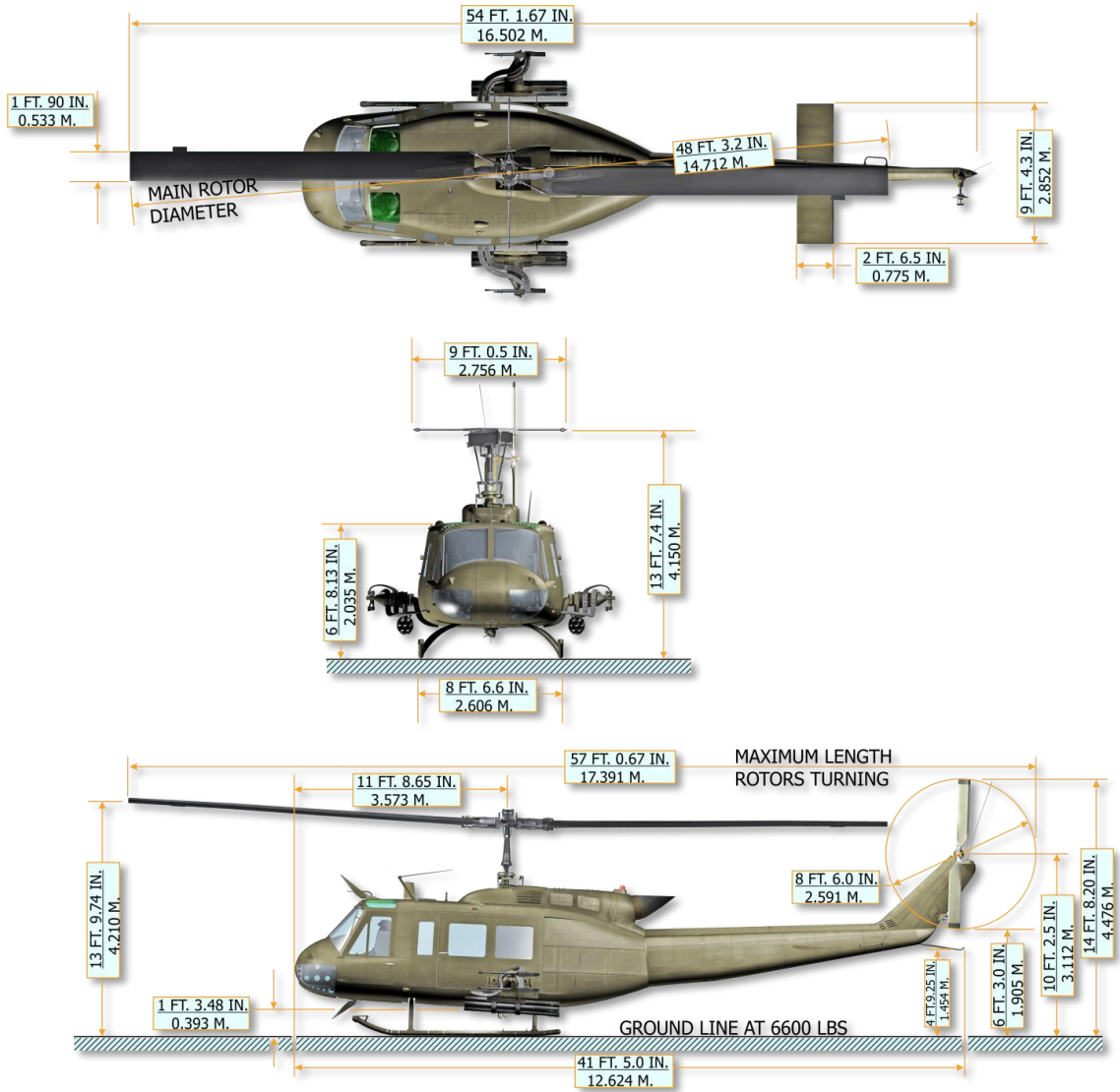
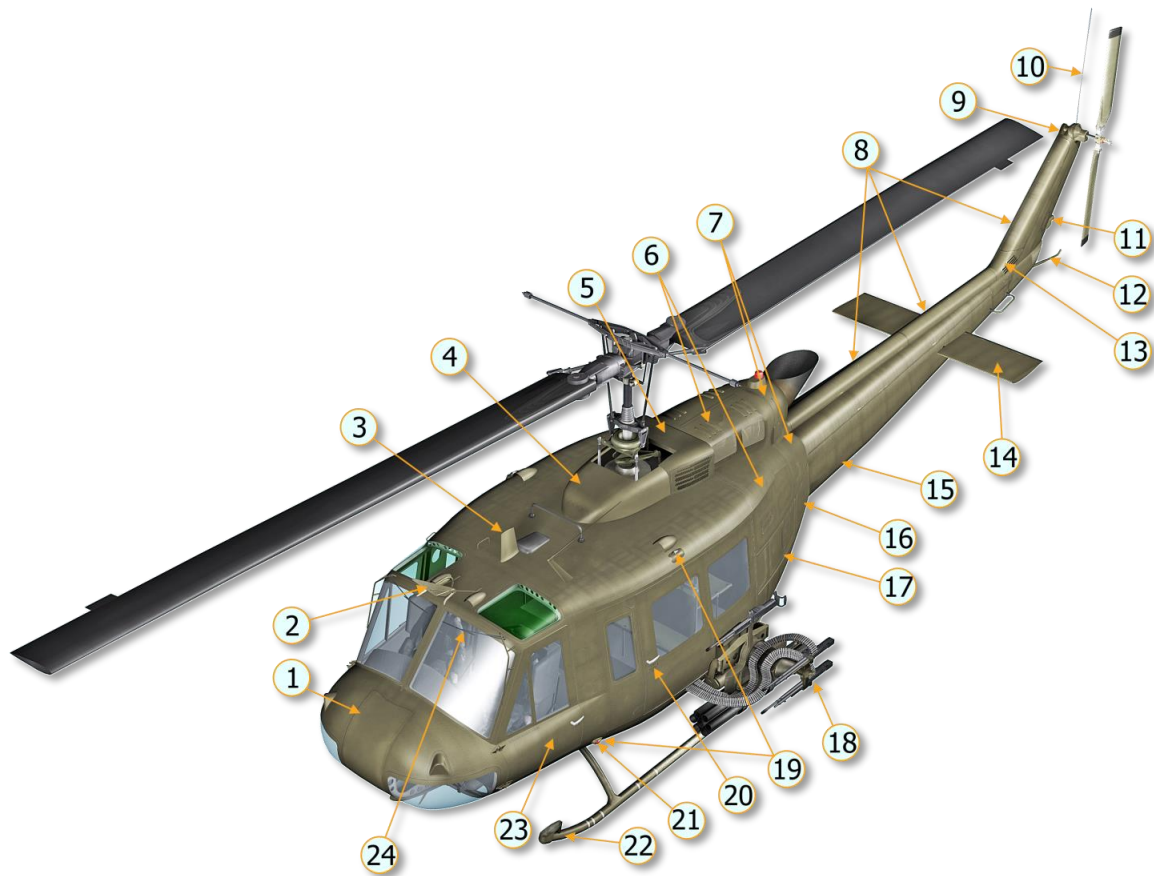

Figure 2.1. UH-1H helicopter dimensions.

2.3. General Assembly Diagram



- | | |
|---|--|
| 1. Radio compartment and fwd battery location access door | 13. 42 degree gearbox |
| 2. Wire-Strike Protection System (WSPS) upper cutter | 14. Synchronized elevator |
| 3. VHF/UHF antenna | 15. Tail boom |
| 4. Transmission fairing | 16. Electrical compartment access door |
| 5. Engine intake fairing | 17. Aft radio compartment access doors |
| 6. Engine cowling | 18. M21 armament sub-system |
| 7. Tailpipe fairing | 19. Position light (NVG) |
| 8. Driveshaft covers | 20. Sliding cargo door |
| 9. 90 degree gearbox | 21. Position light (Red) |
| 10. FM communications antenna No.1 | 22. Landing gear |
| 11. Aft position light (NVG) | 23. Copilot door |
| 12. Tail skid | 24. WSPS windshield deflector |

Figure 2.2. General assembly of the UH-1H (top-left-front).



- | | |
|---|---|
| 1. VHF navigation (Omni) antenna | 9. VHF/UHF antenna |
| 2. Synchronized elevator | 10. Pitot tube |
| 3. Anti-collision light | 11. Pilot door |
| 4. FM homing antenna No.1 | 12. M21 Armament subsystem |
| 5. Loop (ADF) antenna | 13. Position lights (Green upper and lower) |
| 6. Position light (White) | 14. Heater compartment access door |
| 7. Position light (Red) | 15. Oil cooler fan access door |
| 8. FM communications antenna No.2 (mission antenna) | 16. Stabilizer bar |

Figure 2.3. General assembly of the UH-1H (top-right-front).



- | | |
|--|---------------------------|
| 1. Radar warning antenna, FWD | 6. Oil cooler IR shield |
| 2. FM communications antenna No.2
(mission antenna) | 7. DC external plug |
| 3. IR exhaust suppressor | 8. Cargo suspension hook |
| 4. Radar warning antenna, AFT | 9. WSPS lower cutter |
| 5. Radar altimeter antennas (optional) | 10. Position lights (NVG) |

Figure 2.4. General assembly of the UH-1H (below-left-behind).

2.4. Engine and Related Systems

2.4.1. Description of the engine

The power system of the UH-1H consists of a single Textron Lycoming T53-L-13B turboshaft engine with a maximum output power of 1100 kW/1400 hp.

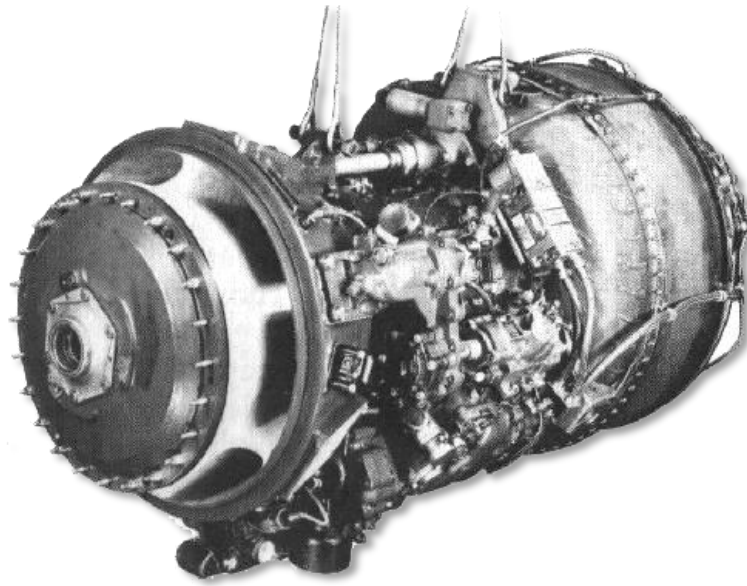
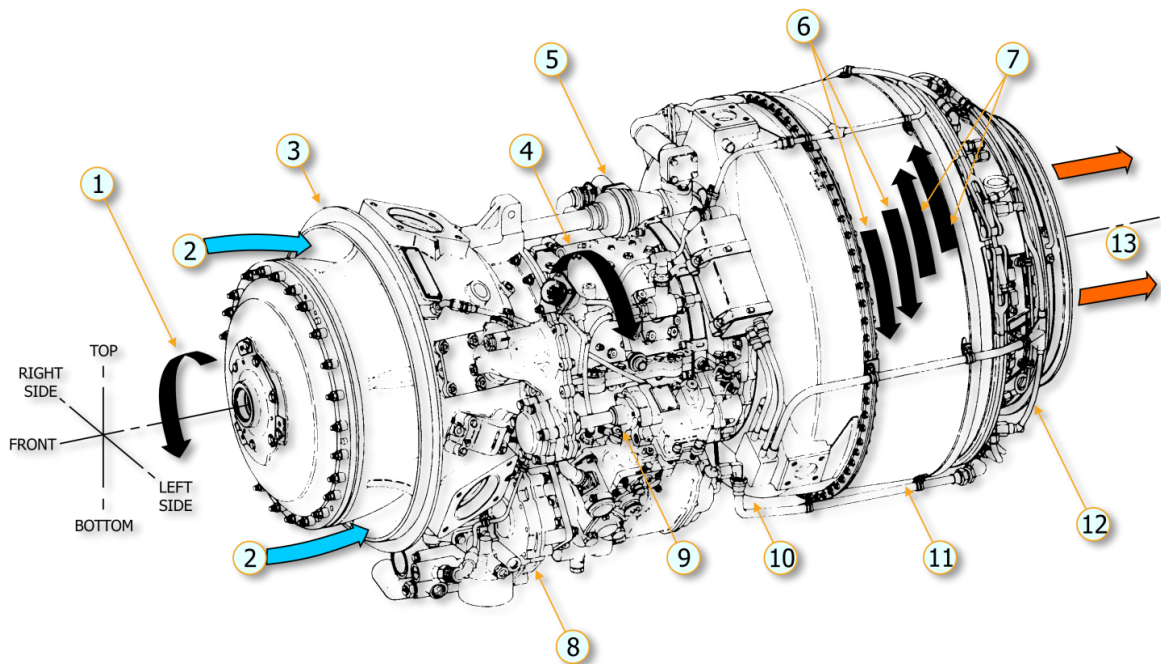

Figure 2.5. T53-L-13B engine.



- | | |
|--|-------------------------------------|
| 1. Rotation of output gearshaft | 7. Rotation of power turbine rotors |
| 2. Air inlet | 8. Accessory drive gearbox |
| 3. Air inlet section | 9. Compressor section |
| 4. Rotation of compressor rotor | 10. Diffuser section |
| 5. Hot air solenoid valve | 11. Combustion section |
| 6. Rotation of gas producer turbine rotors | 12. Exhaust section |
| | 13. Rear exhaust |

Figure 2.6. Internal layout of the T53-L-13B engine (1 of 2)

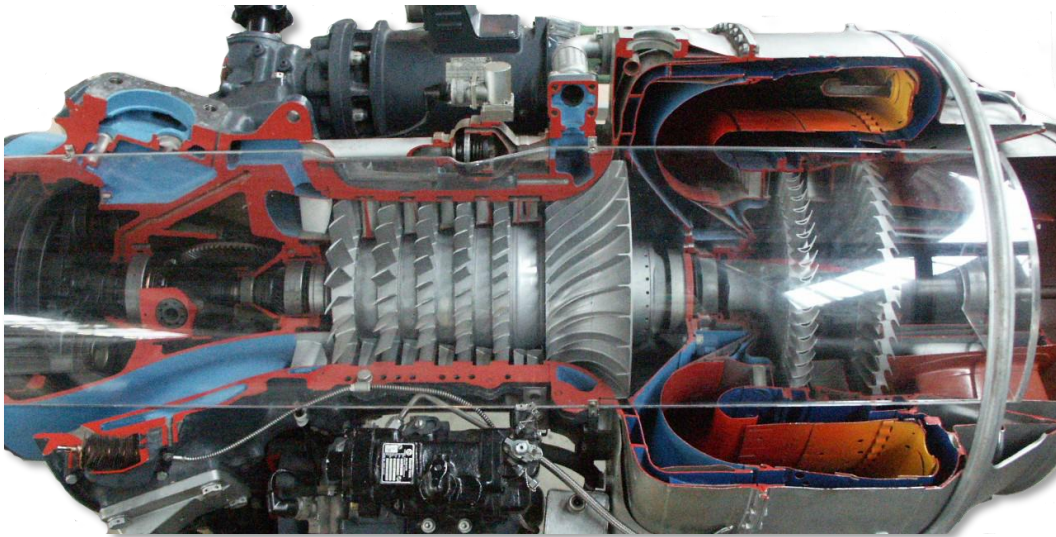

Figure 2.7. Internal layout of the T53-L-13B engine (2 of 2)

Lycoming T53-L-13B specifications:

Power Rating, shp	1400
Air consumption, lbs/s	13
kg/s	6
Compression Ratio	7,2:1 @ 25,600 rpm
Specific Fuel Consumption, lbs/shp/h	0.58
kg/shp/h	0,263
Burner: reverse flow annular, fuel nozzles	22
Dimensions Engine, inch / mm	
diameter	22.99 / 584
length	47.6 / 1209
Weight lbs / kg	549 / 249
Rated revolutions power turbine, /min	22.000
Rated revolutions driveshaft, /min	6600
Rated Torque Output at full power	1,200 lb/ft @ 6,640 rpm
Peak Torque Output	1,700 lb/ft @ 1,800 rpm
Turbine entry temperature, °C	938
Compressor	
axial	5 stage
centrifugal	1 stage

2.4.2. Engine Fuel Control System

A. Engine Mounted Components

The fuel control assembly is mounted on the engine. It consists of a metering section, a computer section and an overspeed governor.

- (1) The *METERING SECTION* (#4 in [Figure 2.8](#)) is driven at a speed proportional to N1 speed. It pumps fuel to the engine through

the main metering valve or if the main system falls through the emergency metering valve which is positioned directly by the twist grip throttle.

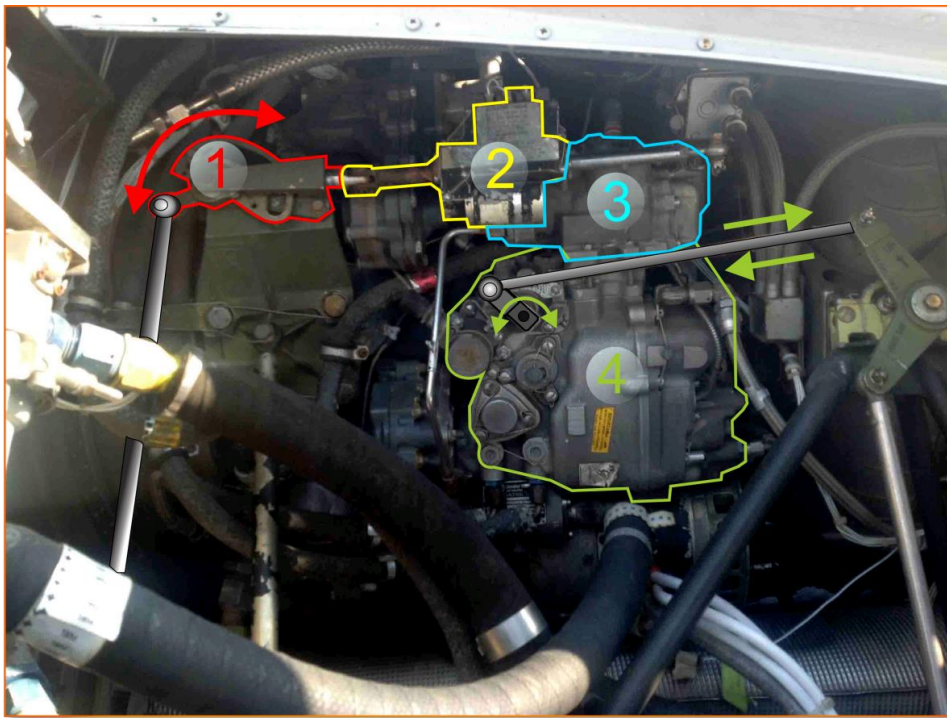

Figure 2.8. Engine-mounted components

1. Droop Compensator
2. Governor Actuator
3. Overspeed Governor
4. Metering and Computer Section (Fuel Control Unit or FCU)

(2) The *COMPUTER SECTION* (also #4 in [Figure 2.8](#)) determines the rate of main fuel delivery by biasing main metering valve opening for N1 speed, inlet air temperature and pressure, and throttle position. It also controls the operation of the compressor air bleed and operation of the variable inlet guide vanes.

- (3) The *OVERSPEED GOVERNOR* (#3 in [Figure 2.8](#)) is driven at a speed proportional to N2 speed. It biases the main metering valve opening to maintain a constant selected N2 rpm.

B. Power Controls (Throttles)

Rotating the pilot or copilot twist grip-type throttle to the full open position ([Figure 2.9](#)) allows the overspeed governor to maintain a constant rpm.

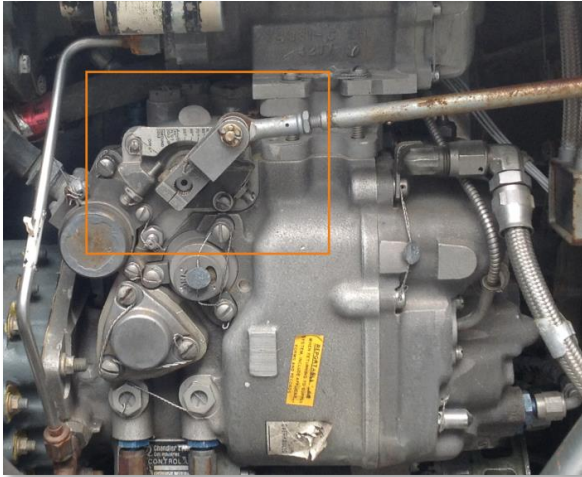

Figure 2.9. FCU. Throttle full open position.

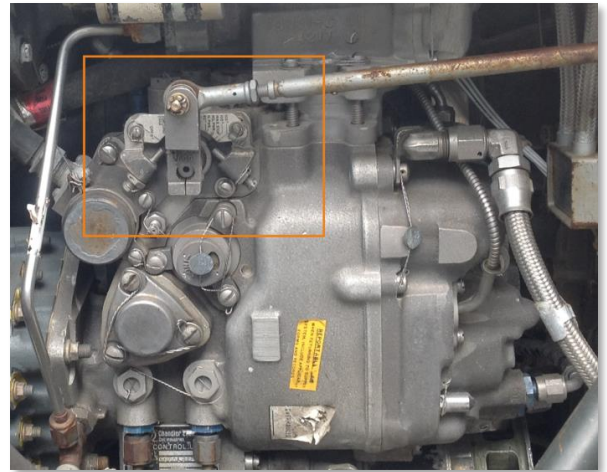

Figure 2.10. FCU. Throttle closed position (idle).

Rotating the throttle toward the closed position ([Figure 2.10](#)) will cause the rpm to be manually selected instead of automatically selected by the overspeed governor. Rotating the throttle to the fully closed position ([Figure 2.11](#)) shuts off the fuel.

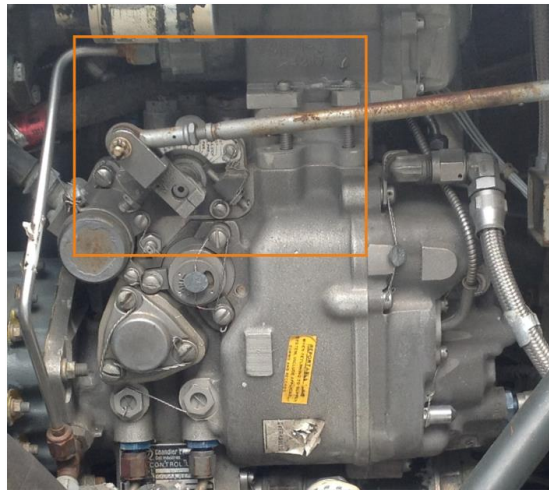

Figure 2.11. FCU. Throttle full closed position.

An idle stop is incorporated in the throttle to prevent inadvertent throttle closure. To bypass the idle detent, press the IDLE REL switch and close the throttle.

C. Governor switch

The [GOV switch](#) is located on the ENGINE control panel. AUTO position permits the overspeed governor to automatically control the engine rpm with the

throttle in the full open position. The EMER position permits the pilot or copilot to manually control the rpm. Because automatic acceleration, deceleration, and overspeed control are not provided with the GOV switch in the EMER position, control movements must be smooth to prevent compressor stall, overspeed, over-temperature, or engine failure.

Note. If GOV switch is in EMER position and throttle is full opened, main rotor rpm can exceed the limit, so pilot should control engine and rotor rpm manually by rotating the throttle twist grip.

2.4.3. Engine Oil Supply System

The system consists of an engine oil tank with deaeration provisions, thermostatically controlled oil cooler with bypass valve, pressure transmitter and [pressure indicator](#), low pressure warning switch and indicator ([see Caution Lights Panel](#)), sight gauges and oil supply return vent and breather lines. Pressure for engine lubrication and scavenging of return oil are provided by the engine mounted and engine driven oil pump.

2.4.4. Governor RPM Switch

The pilot and copilot GOV RPM INCR/DECR switches are mounted on a switch box attached to the end of the [collective pitch](#) control lever (Figure 4.6). The switches are a three-position momentary type and are held in INCR (up) position to increase the power turbine (N2) speed or DECR (down) position to decrease the power turbine (N2) speed. Electrical power for the circuit is supplied from the 28 VDC essential bus and is protected by a circuit breaker marked GOV CONT.

2.4.5. Droop Compensator

A droop compensator (#1 in [Figure 2.8](#)) maintains engine rpm (N2) as power demand is increased by the pilot. The compensator is a direct mechanical linkage between the collective stick and the speed selector lever on the N2 governor. No crew controls are provided or required. The compensator will hold N2 rpm to 6600 rpm when properly rigged. Droop is defined as the speed change in engine rpm (N2) as power is increased from a no-load condition. It is an inherent characteristic designed into the governor system. Without this characteristic instability would develop as engine output is increased resulting in N1 speed overshooting or hunting the value necessary to satisfy the new power condition.

2.4.6. Engine Instrument and Indicators

All engine instruments and indicators are mounted in the instrument panel and the pedestal.

- a) [Torquemeter Indicator](#). The torquemeter indicator is located in the center area of the instrument panel and is marked TORQUE PRESS.
- b) [Exhaust Gas Temperature Indicator](#). The exhaust gas temperature indicator is located in the center area of the instrument panel and is marked EXH TEMP.

- c) [Dual Tachometer](#). The dual tachometer is located in the center area of the instrument panel and indicates both the engine and main rotor rpm.
- d) [Gas Producer Tachometer](#). The gas producer indicator is located in the right center area of the instrument panel and is marked PERCENT.
- e) [Oil Temperature Indicator](#). The engine oil temperature indicator is located in the center area of the instrument panel and is marked ENGINE OIL.
- f) [Oil Pressure Indicator](#). The engine oil pressure indicator is located in the center area of the instrument panel and is marked OIL.
- g) [Oil Pressure Caution Light](#). The ENGINE OIL PRESS caution light is located in the pedestal mounted CAUTION panel. The light is connected to a low pressure switch. When pressure drops below approximately 25 psi, the switch closes an electrical circuit causing the caution light to illuminate. The circuit receives power from the 28 VDC essential bus and is protected by the circuit breaker marked CAUTION LIGHTS.
- h) [Engine Chip Detector Caution Light](#). A magnetic plug is installed in the engine. When sufficient metal particles accumulate on the magnetic plug to complete the circuit, the ENGINE CHIP DET segment illuminates. The circuit receives power from the 28 VDC essential bus and is protected by the circuit breaker marked CAUTION LIGHTS. On helicopters equipped with ODDS, the chip detector which is connected to the caution light is part of the external oil separator.
- i) [Engine Ice Detector](#). The ice detector system (ENGINE ICE DET caution light) is not connected.
- j) [Engine Icing Caution Light](#). The ENGINE ICING segment of the caution panel.
- k) [Engine Inlet Air Caution Light](#). The ENGINE INLET AIR segment of the caution panel will illuminate when the inlet air filter becomes clogged. Power is supplied from the 28 VDC bus and protection is provided by the CAUTION LIGHT circuit breaker. *Not implemented in DCS: UH-1H.*
- l) Failure of either [fuel pump](#) element will close an electrical circuit illuminating the caution light. The system receives power from the 28 VDC essential bus and is protected by a circuit breaker marked CAUTION LIGHTS. One type of switch used on some aircraft will illuminate the caution light until normal operating pressure is reached. This momentary lighting does not indicate a pump element failure.
- m) [Emergency Fuel Control Caution Light](#). The emergency fuel control caution light is located in the pedestal-mounted caution panel. The illumination of the worded segment [GOV EMER](#) is a reminder to the

pilot that the GOV switch is in the EMER position. Electrical power for the circuit is supplied from the 28 VDC bus and is protected by a circuit breaker marked CAUTION LIGHTS.

- n) [Fuel Filter Caution Light](#). The FUEL FILTER caution light is located in the pedestal-mounted caution panel or a press to test light is located on the instrument panel. A differential pressure switch is mounted in the fuel line across the filter. When the filter becomes clogged, the pressure switch senses this and closes contacts to energize the caution light circuit. If clogging continues, the fuel bypass opens to allow fuel to flow around the filter. The circuit receives power from the 28 VDC essential bus and is protected by a circuit breaker marked CAUTION LIGHTS. *Not implemented in DCS: UH-1H.*

2.5. Power Train System

The power train is a system of shafts and gearboxes through which the engine drives the main rotor, tail rotor, and accessories, such as the DC generator and the hydraulic pump. The system consists of ([Figure 2.12](#)) a main driveshaft, a main transmission, which includes input and output drives, and the main rotor mast, and a series of driveshafts with two gearboxes through which the tail rotor is driven.

A. Transmission

The main transmission is mounted forward of the engine and coupled to the power turbine shaft at the cool end of the engine by the main driveshaft. The transmission is basically a reduction gearbox, used to transmit engine power at a reduced rpm to the rotor system. A freewheeling unit is incorporated in the transmission to provide a quick-disconnect from the engine if a power failure occurs. This permits the main rotor and tail rotor to rotate in order to accomplish a safe auto-rotational landing. The tail rotor drive is on the lower aft section of the transmission. Power is transmitted to the tail rotor through a series of driveshaft and gearboxes. The rotor tachometer generator, hydraulic pump, and main DC generator are mounted on and driven by the transmission. A self-contained pressure oil system is incorporated in the transmission. The oil is cooled by an oil cooler and turbine fan. The engine and transmission oil coolers use the same fan. The oil system has a thermal bypass capability. An oil level sight glass, filler cap, and magnetic chip detector are provided. A transmission oil filter is mounted in a pocket in the upper right aft corner of sump case, with inlet and outlet ports through internal passages. The filter incorporates a bypass valve for continued oil flow if screens become clogged. The transmission external oil filter is located in the cargo-sling compartment on the right side wall, and is connected into the external oil line. On helicopters equipped with ODDS¹, a full flow debris monitor with integral chip detector replaces the integral oil filter. A bypass valve is incorporated, set to open at a

¹ ODDS – Oil Debris Detection System – ODDS improves oil filtration and reduces nuisance chip indications caused by normal wear particles on detector gaps. When a chip gap is bridged by conductive particles, a power module provides an electrical pulse which burns away normal wear particles.

set differential pressure to assure oil flow if filter element should become clogged.

Normal revolution (min^{-1}): main rotor (mast): 324, tail rotor: 1782.

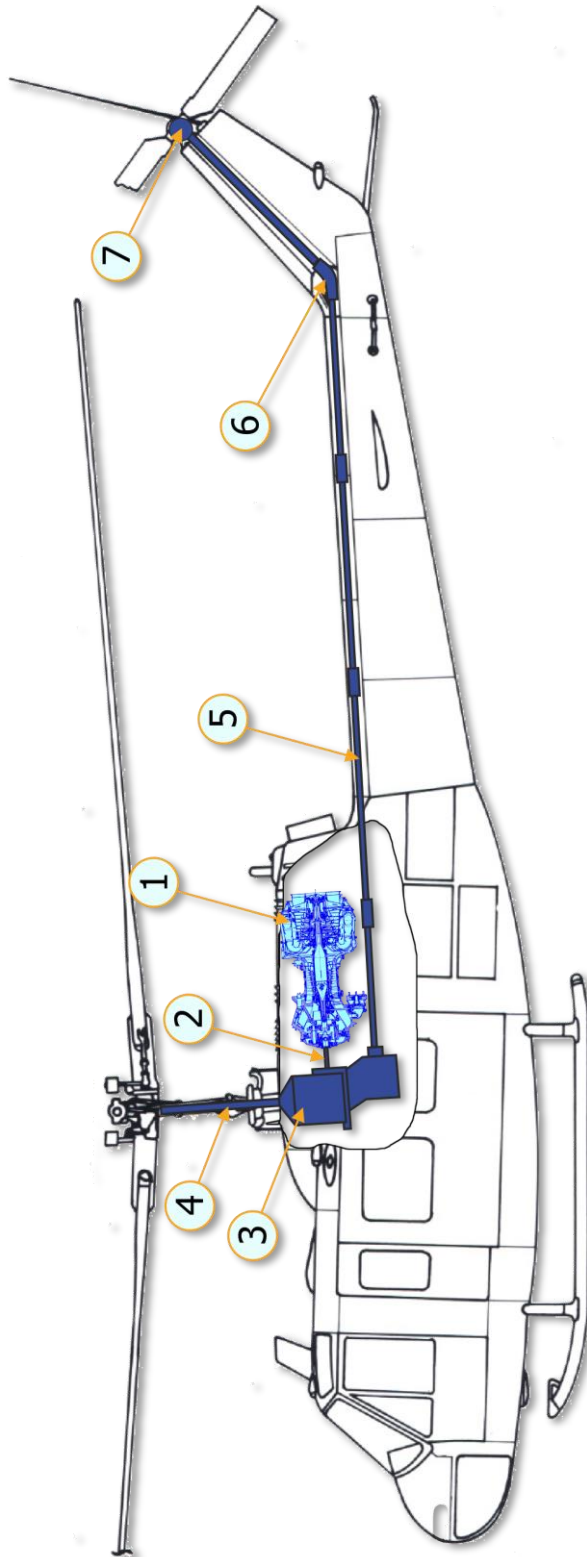

Figure 2.12. Power train diagram

1. [Engine](#)
2. [Main Driveshaft](#) (6600 RPM)
3. [Transmission](#)
4. Mast (324 RPM)
5. [Tail Rotor Driveshafts](#)
6. [Intermediate Gearbox](#) (42°)
7. [Tail Rotor Gearbox](#) (90°, 1782 RPM)

B. Gearboxes

INTERMEDIATE GEARBOX 42 DEGREE. The 42 degree gearbox is located at the base of the vertical fin. It provides 42 degree change of direction of the tail rotor driveshaft. The gearbox has a self-contained wet sump oil system. An oil level sight glass, filler cap, vent and magnetic chip detector are provided.

TAIL ROTOR GEARBOX 90 DEGREE. The 90 degree gearbox is located at the top of the vertical fin. It provides a 90 degree change of direction and gear reduction of the tail rotor driveshaft. The gearbox has a self-contained wet sump oil system. An oil level sight glass, vented filler cap and magnetic chip detector are provided.

C. Driveshafts

MAIN DRIVESHAFT. The main driveshaft connects the engine output shaft to the transmission input drive quill.

TAIL ROTOR DRIVESHAFT. The tail rotor driveshaft consists of six driveshaft and four hanger bearing assemblies. The assemblies and the 42 degree and 90 degree gearboxes connect the transmission tail rotor drive quill to the tail rotor. To [Figure 2.12. Power Train Diagram](#)

D. Indicators and Caution Lights

- a) [Transmission Oil Pressure Indicator](#). The TRANS OIL pressure indicator is located in the center area of the instrument panel. It displays the transmission oil pressure in psi. Electrical power for the circuit is supplied from the 28 VAC bus and is protected by the XMSN circuit breaker in the AC circuit breaker panel.
- b) [Transmission Oil Pressure Low Caution Light](#). The XMSN OIL PRESS segment in the CAUTION panel will illuminate when the transmission oil pressure drops below about 30 psi. The circuit receives power from the essential bus. Circuit protection is supplied by the CAUTION LIGHTS circuit breaker.
- c) [Transmission Oil Temperature Indicator](#). The transmission oil temperature indicator is located in the center area of the instrument panel. The indicator displays the temperature of the transmission oil in degrees Celsius. The electrical circuit receives power from the essential bus and is protected by the TEMP IND ENG XMSN circuit breaker in the DC breaker panel. This is a wet bulb system dependent on fluid for valid indication.
- d) [Transmission Oil Hot Caution Light](#). The XMSN OIL HOT segment in the CAUTION panel will illuminate when the transmission oil temperature is above 110°C (230°F). The circuit receives power from the essential bus and is protected by the CAUTION LIGHTS circuit breaker. This is a wet bulb system dependent on fluid for valid indication.
- e) Transmission and Gearbox Chip Detector:

- (1) [Chip Detector Caution Light](#). Magnetic inserts are installed in the drain plugs of the transmission sump, 42 degree gearbox and the 90 degree gearbox. On helicopters equipped with ODDS, the transmission chip gap is integral to a full-flow debris monitor. When sufficient metal particles collect on the plugs to close the electrical circuit, the CHIP DETECTOR segment in the CAUTION panel will illuminate. A self-closing, spring-loaded valve in the chip detectors permits the magnetic probes to be removed without the loss of oil. The circuit is powered by the essential bus and protected by the CAUTION LIGHTS circuit breaker.
- (2) [Chip Detector Switch](#). A CHIP DET switch is installed on a pedestal mounted panel. The switch is labeled BOTH, XMSN, and TAIL ROTOR and is spring-loaded to the BOTH position. When the CHIP DETECTOR segment in the CAUTION panel lights up, position the switch to XMSN, then TAIL ROTOR to determine the trouble area. CHIP DET caution light will remain on when a contaminated component is selected. The light will go out if the non-contaminated component is selected.

2.6. Cockpit layout

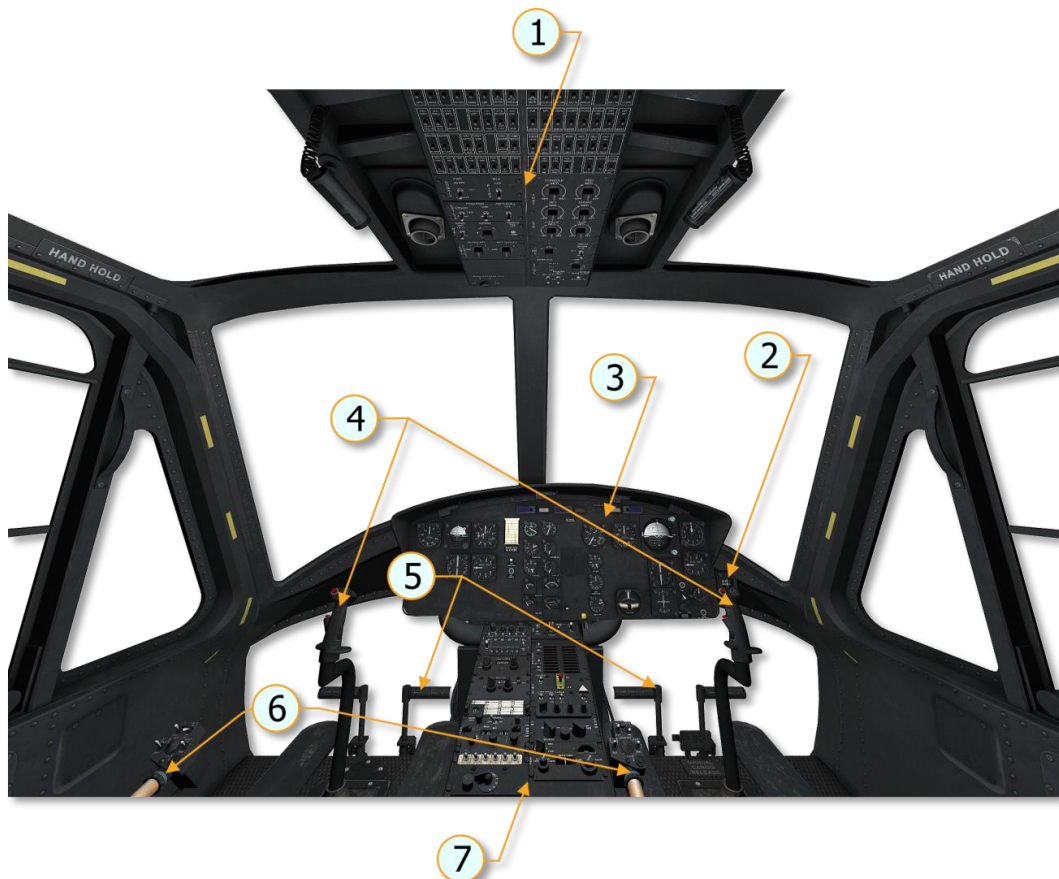

Figure 2.13. UH-1H cockpit layout

- | | |
|-------------------------------------|--|
| 1. Overhead Console | 5. Tail Rotor Control System |
| 2. Standby Compass | 6. Collective Control System |
| 3. Instrument Panel | 7. Pedestal Panel |



3

HELICOPTER AERODYNAMICS

3. HELICOPTER AERODYNAMICS

3.1.1. Forces Acting On a Helicopter

Weight (G) and drag (Q) act on a helicopter as they do on any aircraft; however, lift (T_y) and thrust (T_x) for a helicopter are obtained from the main rotor (T_{rotor}). In a very basic sense, the helicopter's main rotor does what wings and a propeller do for a fixed-wing aircraft. Moreover, by tilting the main rotor, the pilot can make the helicopter fly to either side, forward, or backwards.

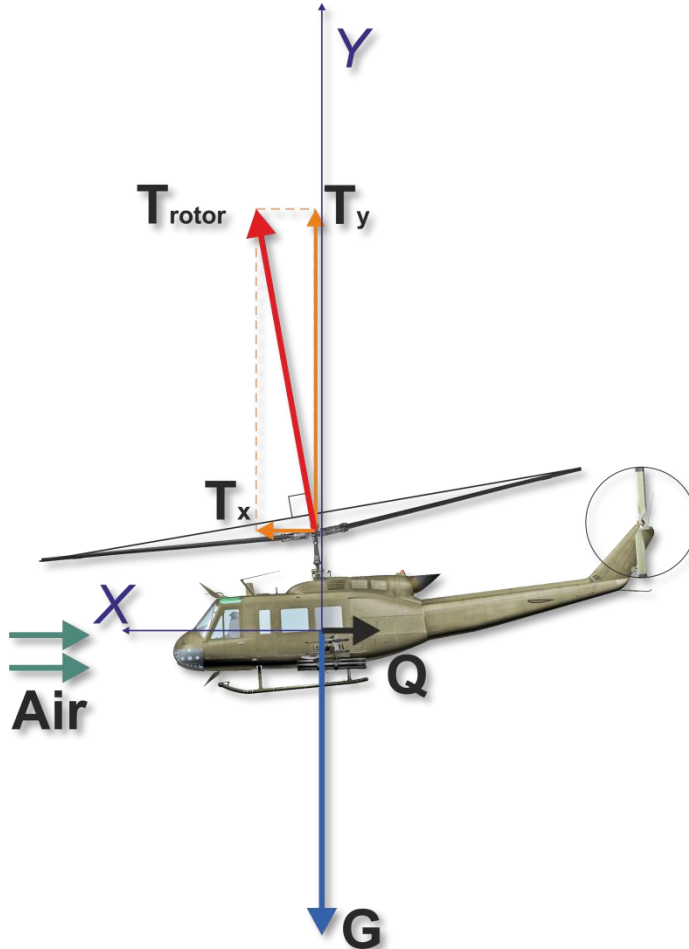

Figure 3.1. Forces acting on a helicopter

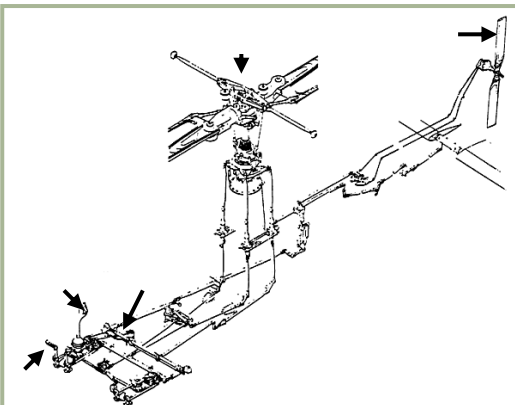

Figure 3.2. Helicopter controls

3.1.2. Controls

The sketch in [Figure 3.2](#) shows the main rotor, cyclic and collectives, anti-torque pedals, and anti-torque (tail) rotor. Basically, the cyclic control is a mechanical linkage used to change the pitch of the main rotor blades. Pitch change is accomplished at a specific point in the plane of rotation to tilt the main rotor disc.

Most current military helicopters now have hydraulic assistance in addition to the mechanical linkages. The collective changes the pitch of all the main rotor blades equally and simultaneously. The anti-torque pedals are used to adjust the pitch in the anti-torque rotor blades to compensate for main rotor torque.

3.1.3. Velocity

A helicopter's main rotor blades must move through the air at a relatively high speed in order to produce enough lift to raise the helicopter and keep it in the air. When the main rotor reaches required takeoff speed and generates a great deal of torque, the anti-torque rotor can negate fuselage rotation.

The helicopter can fly forward, backward, and sideways according to pilot control inputs. It can also remain stationary in the air (hover) with the main rotor blades developing enough lift to hover the helicopter.

3.1.4. Torque

The torque problem is related to a helicopter's single-main-rotor design. The reason for this is that the helicopter's main rotor turns in one direction while the fuselage wants to turn in the opposite direction. This effect is based on Newton's third law that states "To every action there is an opposite and equal reaction." The torque problem on single-rotor helicopters is counteracted and controlled by an anti-torque (tail) rotor.

On coaxial helicopters, the main rotors turn in opposite directions and thereby eliminate the torque effect.

3.1.5. Anti-torque Rotor

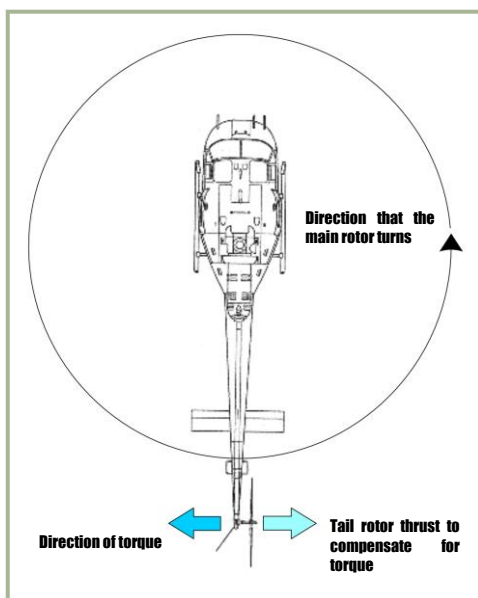

[Figure 3.3](#) shows the direction of travel of the main rotor, the direction of torque of the fuselage, and the location of the anti-torque (tail) rotor.

An anti-torque rotor located on the end of a tail boom provides torque compensation for single-main-rotor helicopters. The tail rotor, driven by the engine at a constant speed, produces thrust in a horizontal plane opposite to the torque reaction developed by the main rotor.

Figure 3.3. Tail rotor and thrust

3.1.6. Gyroscopic Precession

The result of applying force against a rotating body occurs at 90° in the direction of rotation from where the force is applied. This effect is called gyroscopic precession and it is illustrated in [Figure 3.4](#). For example: if a downward force is applied at the 9 o'clock position in the diagram, then the result appears at the 6 o'clock position as shown. This will result in the 12 o'clock position tilting up an equal amount in the opposite direction.

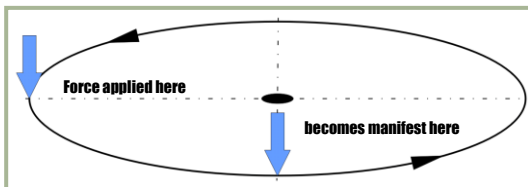

Figure 3.4. Gyroscopic precession

Figure 3.5 illustrates the offset control linkage needed to tilt the main rotor disc in the direction the pilot inputs with the cyclic. If such a linkage were not used, the pilot would have to move the cyclic 90° to the right of the desired direction. The offset control linkage is attached to a lever extending 90° in the

direction of rotation from the main rotor blade.

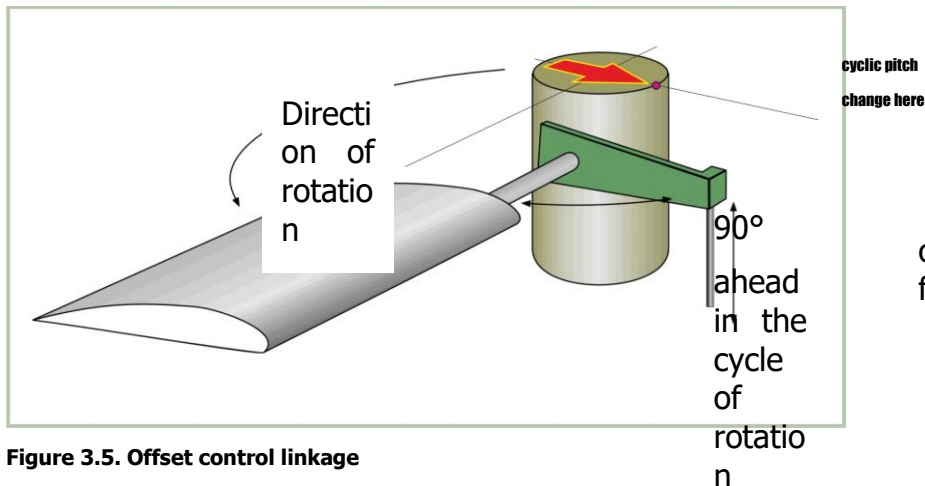

Figure 3.5. Offset control linkage

3.1.7. Dissymmetry of Lift

The area within the circle made by the rotating blade tips of a helicopter is known as the disc area or rotor disc. When hovering in still air, lift generated by the rotor blades is equal within all parts of the disc. Dissymmetry of lift is the difference in lift that exists between the advancing half of the disc and the retreating half; this is created by horizontal flight and/or wind.

When a helicopter is hovering in still air, the tip speed of the advancing blade is approximately 600 feet per second (~ 183 m/s) and the tip speed of the retreating blade is the same. Dissymmetry of lift is created by the movement of the helicopter in forward flight. The advancing blade has the combination of blade speed velocity and that of the helicopter's forward airspeed. The retreating blade however loses speed in proportion to the forward speed of the helicopter.

Figure 3.6 illustrates dissymmetry of lift and shows the arithmetic involved in calculating the differences between the velocities of the advancing and retreating blades. In the figure, the helicopter is moving forward at a speed of 50 m/s, the velocity of the rotor disc is equal to approximately 180 m/s, and the

advancing blade speed is 230 m/s. The speed of the retreating blade is 130 m/s. This speed is obtained by subtracting the speed of the helicopter (50 m/s) from the tip speed of 180 m/s. As can be seen from the difference between the advancing and retreating blade velocities, a large speed and lift variation exists.

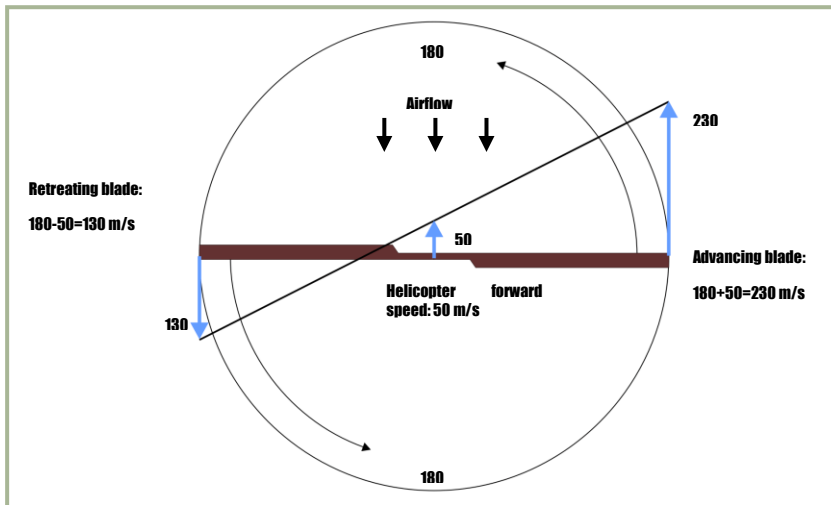

Figure 3.6. Dissymmetry of lift. (ROTATIONAL VELOCITY) \pm (HEL FORWARD SPEED) = (AIRSPEED OF BLADE).

Cyclic pitch control, a design feature that permits changes in the angle of attack during each revolution of the rotor, compensates for the dissymmetry of lift. As the forward speed of the helicopter is increased, the pilot must apply more and more cyclic to hold a given rotor disc attitude. The mechanical addition of more pitch to the retreating blade and less to the advancing blade is continued throughout the helicopter's range.

3.1.8. Retreating Blade Stall

Figure 3.7 illustrates the tendency of a helicopter's retreating blades to stall in forward flight. This is a major factor in limiting a helicopter's maximum forward airspeed. Just as the stall of a fixed wing aircraft wing limits the low-air-speed flight envelope, the stall of a rotor blade limits the high-speed potential of a helicopter. The airspeed of a retreating blade slows down as forward airspeed is increased. The retreating blade must produce an amount of lift equal to that of the advancing blade, as shown in Figure 3.8. As the airspeed of the retreating blade is decreased with forward airspeed, the blade angle of attack must be increased to equalize lift throughout the rotor disc area. As this angle of attack is increased, the blade will eventually stall at some high, forward airspeed as shown in Figure 3.9.

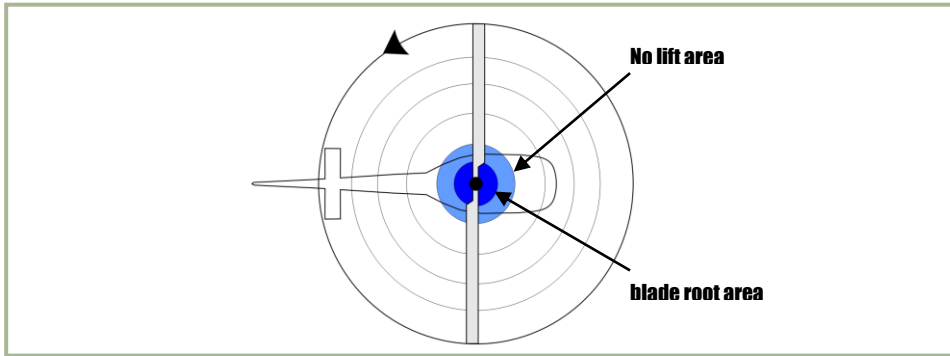

Figure 3.7. Hovering lift pattern

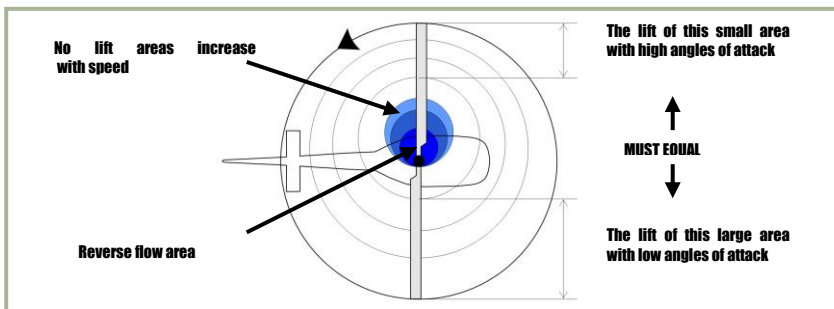

Figure 3.8. Normal cruise lift pattern

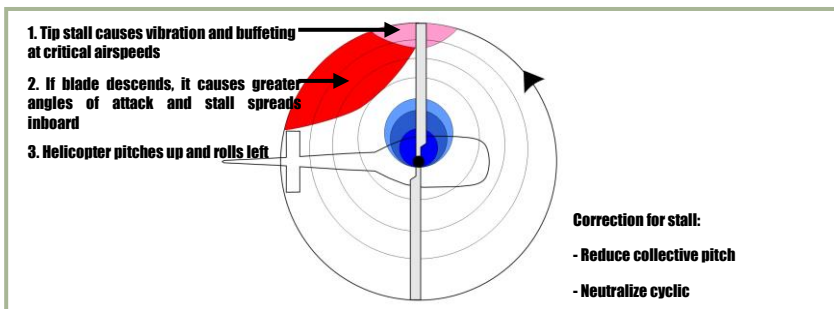

Figure 3.9. Lift pattern at critical airspeed

Upon entry into a retreating blade stall, the first noticeable effect is vibration of the helicopter. This vibration is followed by the helicopter's nose lifting with a rolling tendency. If the cyclic is held forward and the collective is not reduced, the stall will become aggravated and the vibration will increase greatly. Soon thereafter, the helicopter may become uncontrollable.

3.1.9. Settling with Power (Vortex Ring State)

Settling with power is a condition of powered flight when the helicopter settles into its own main rotor downwash; this is also known as Vortex Ring State.

Conditions conducive to settling with power include a vertical, or nearly vertical, descent of at least 300 feet per minute with low forward airspeed. The rotor system must also be using some of the available engine power (from 20 to 100%) with insufficient power available to retard the sink rate. These conditions occur during approaches with a tailwind or during formation approaches when some aircraft are flying in the downwash of other aircraft.

Under the conditions described above, the helicopter may descend at a high rate that exceeds the normal downward induced flow rate of the inner blade

sections. As a result, the airflow of the inner blade sections is upward relative to the disk. This produces a secondary vortex ring in addition to the normal tip vortex. The secondary vortex ring is generated at about the point on the blade where airflow changes from up to down. The result is an unsteady turbulent flow over a large area of the disk that causes loss of rotor efficiency, even though power is still applied.

This graphic shows induced flow along the blade span during normal hovering flight:

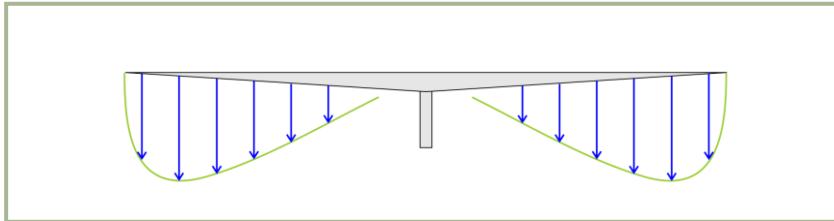

Figure 3.10. Induced flow velocity during hovering flight

The downward velocity is highest at the blade tip where blade airspeed is highest. As blade airspeed decreases towards the center of the disk, downward velocity is less.

Figure 3.11 shows the induced airflow velocity pattern along the blade span during a descent conducive to settling with power:

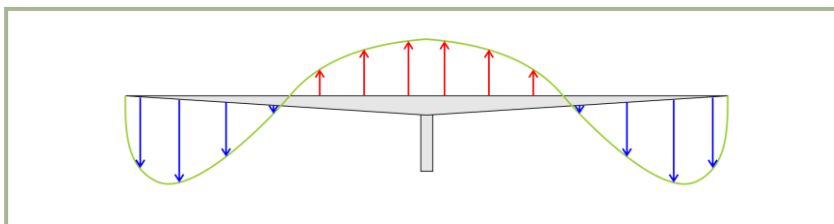

Figure 3.11. Induced flow velocity during vortex ring state

The descent is so rapid that induced flow at the inner portion of the blades is upward rather than downward. The upward flow caused by the descent can overcome the downward flow produced by blade rotation. If the helicopter descends under these conditions, with insufficient power to slow or stop the descent, it will enter a vortex ring state:

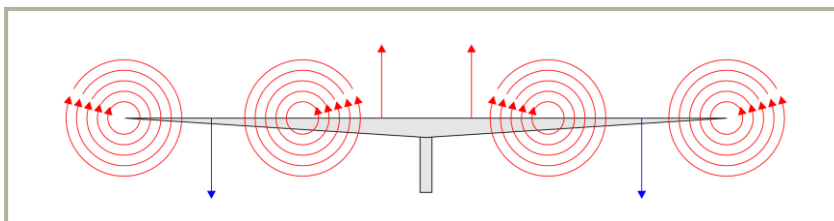

Figure 3.12. Vortex rotation flows along the blades during VRS

During a vortex ring state, roughness and loss of control is experienced because of the turbulent rotational flow on the blades and the unsteady shifting of the flow along the blade span.

Power settling is an unstable condition, and if allowed to continue, the sink rate will reach sufficient proportions for the flow to be entirely up through the rotors.

This can result in very high descent rates. Recovery may be initiated during the early stages of power settling by putting on a large amount of excess power. This excess power may be sufficient to overcome the upward flow near the center of the rotor disc. If the sink rate reaches a higher rate, power will not be available to break this upward flow and thus alter the vortex ring state of flow.

Normal tendency is for pilots to recover from a descent by application of collective pitch and power. If insufficient power is available for recovery, this action may aggravate power settling and result in more turbulence and a higher rate of descent. Recovery can be accomplished by lowering collective pitch and increasing forward speed (pushing the cyclic forward). Both of these methods of recovery require sufficient altitude to be successful.

3.1.10. Hovering

A helicopter hovers when it maintains a constant position over a point on the ground, usually a few feet above the ground. To hover, a helicopter's main rotor must supply lift equal to the total weight of the helicopter, including crew, fuel, and if applicable, passengers, cargo, and armaments. The necessary lift is generated by rotating the blades at high velocity and increasing the collective pitch angle of the rotor blades.

When hovering, the rotor system requires a large volume of air upon which to work. This air must be pulled from the surrounding air mass; this is an expensive maneuver that takes a great deal of engine horsepower. The air delivered through the rotating blades is pulled from above at a relatively high velocity, forcing the rotor system to work in a descending column of air.

The main rotor vortex and the recirculation of turbulent air add resistance to the helicopter while hovering. Such an undesirable air supply requires higher blade angles of attack and an expenditure of more engine power and fuel. Additionally, the main rotor is often operating in air filled with abrasive materials that cause heavy wear on helicopter parts while hovering in the ground effect.

3.1.11. Ground Effect

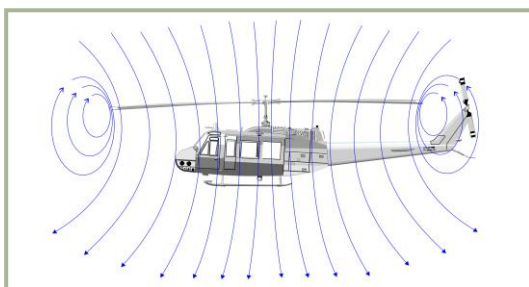

Figure 3.13. Airflow when out of ground effect

Ground effect is a condition of improved performance found when hovering near the ground. The best height is approximately one-half the main rotor diameter. Figure 3.13 shows "out of ground effect" and 3.14 shows "in ground effect".

The improved lift and airfoil efficiency while operating in ground effect is due to the following effects:

First, and most importantly, the main rotor-tip vortex is reduced. When operating in the ground effect, the downward and outward airflow reduces the vortex. A vortex is an airflow rotating around an axis or center.

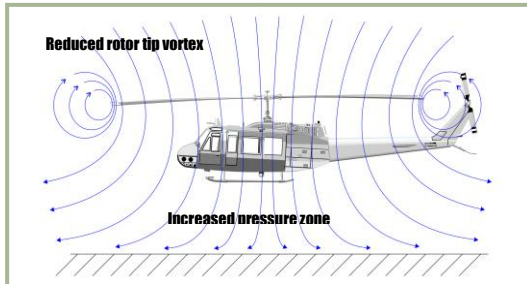

Figure 3.14. Airflow when in ground effect

This makes the outward portion of the main rotor blade more efficient. Reducing the vortex also reduces the turbulence caused by recirculation of the vortex.

Second, the airflow angle is reduced as it leaves the airfoil. When the airfoil angle is reduced, the resultant lift is rotated slightly forward; this makes the angle more vertical. Reduction of induced drag permits lower angles of attack for the same amount of lift and it reduces the power required to rotate the blades.

3.1.12. Translational Lift

The efficiency of the hovering rotor system is improved by each knot of incoming wind gained by forward motion of the helicopter or by a surface headwind. As the helicopter moves forward, fresh air enters in an amount sufficient to relieve the hovering air-supply problem and improve performance. At approximately 40 km/h, the rotor system receives enough free, undisturbed air to eliminate the air supply problem. At this time, lift noticeably improves and the helicopter begins to climb. This distinct change is referred to as translational lift. At the instant of translational lift, and as the hovering air supply pattern is broken, dissymmetry of lift is created. As airspeed increases, translational lift continues to improve up to the speed that is used for best climb.

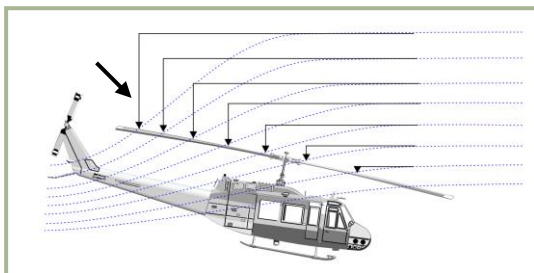

Figure 3.15. Translational lift

In forward flight, air passing through the rear portion of the rotor disc has a higher downwash velocity than the air passing through the forward portion.

This is known as transverse flow effect and is illustrated in figure 3.15. This effect, in combination with gyroscopic precession, causes the rotor to tilt sideward and results in vibration that is most noticeable on entry into effective translation.

3.1.13. Autorotation

If engine power fails, or other emergencies occur, autorotation is a means of safely landing a helicopter. The transmission in a helicopter is designed to allow the main rotor to turn freely in its original direction when the engine stops. Figure 3.16 illustrates how the helicopter is allowed to glide to earth and by using the main rotor rpm, make a soft landing.

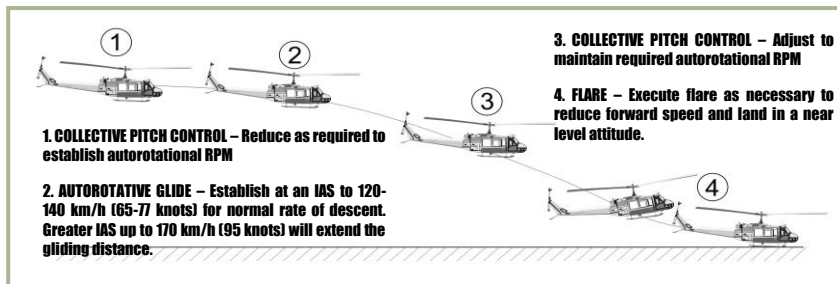

Figure 3.16. Approach to landing, power off

In autorotation, the helicopter pilot exchanges potential energy (altitude) for kinetic energy (speed) required to maintain rotor RPM. This is accomplished by establishing a gliding descent to provide sufficient continuous airflow for the rotor system.

As shown in Figure 3.17, the rotor disc dynamics during autorotation can be broken into three regions: outboard, middle and inboard.

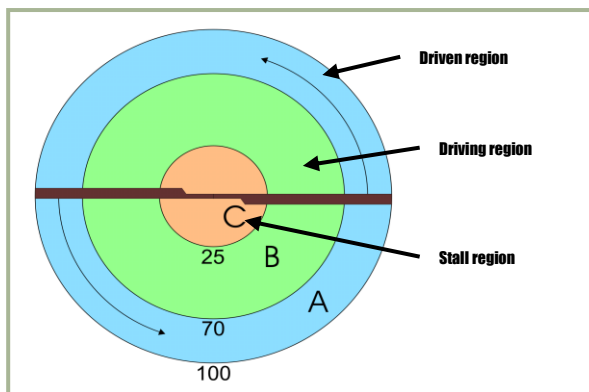

Figure 3.17. The rotor blade autorotative regions

force are equal.

B: The rotor blade autorotative driving region is the portion of the blade between 25 to 70 percent radius. Because this region operates at a comparatively high angle of attack, the result is a slight but important forward inclination of aerodynamic forces. This inclination supplies thrust slightly ahead of the rotating axis and tends to speed up this portion of the blade during autorotation.

A: The blade area outboard of the 70 percent circle is known as the propeller or driven region. Analysis of blade region A indicates the aerodynamic force inclines slightly behind the rotating axis. This inclination causes a small drag force that tends to slow the tip portion of the blade. Rotor rpm stabilizes, or achieves equilibrium, when autorotative force and antiautorotative

C: The blade area inboard of the 25% circle is known as the stall region, because it operates above its maximum angle of attack. This region contributes considerable drag that tends to slow the blade.

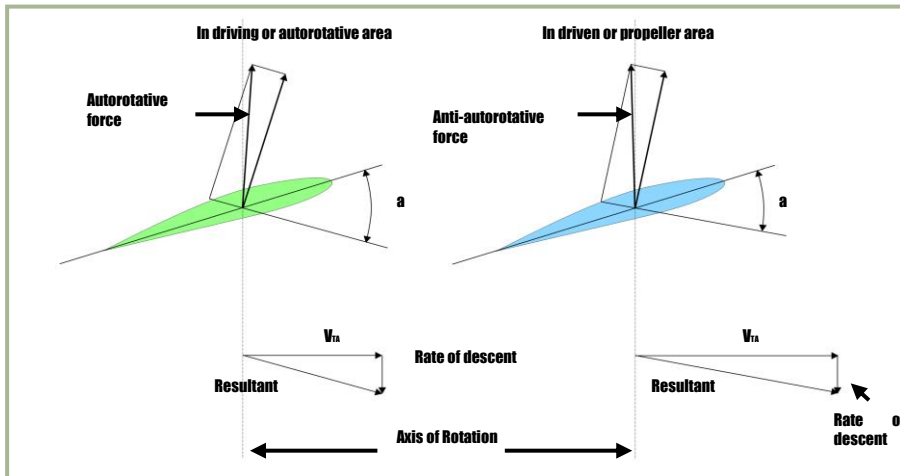

Figure 3.18. Autorotation blade forces

All helicopters carry an operator's manual that has an airspeed versus altitude chart similar to the one shown in Figure 3.19. The shaded areas on this chart must be avoided. This area is referred to as the "dead man's curve" and "avoid curve". The proper maneuvers for a safe landing during engine failure cannot be accomplished in these areas.

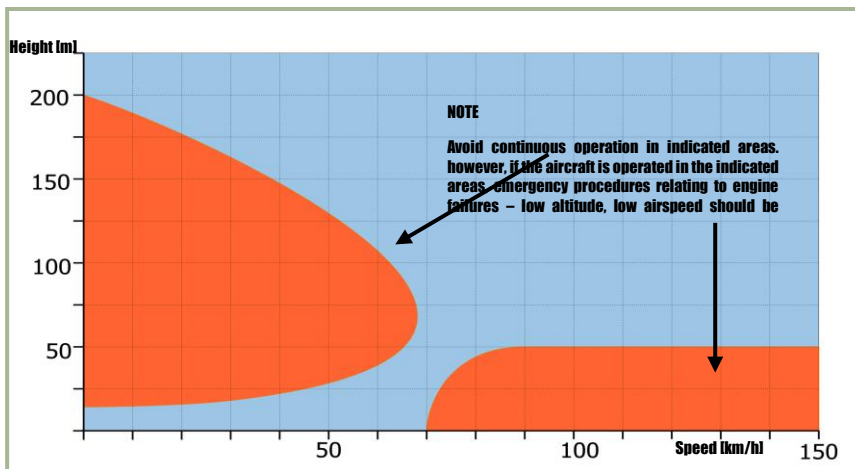

Figure 3.19. Height-velocity diagram

3.1.14. Summary

Weight, lift, thrust, and drag are the four forces acting on a helicopter. The cyclic for directional control, the collective pitch for altitude control, and the anti-torque pedals to compensate for main rotor torque are the three main controls used in a helicopter.

Torque is an inherent problem with single-main-rotor helicopters. Gyroscopic precession occurs at approximately 90° in the direction of rotation from the point where the force is applied. Dissymmetry of lift is the difference in lift that exists between the advancing and retreating halves of the rotor disc.

Settling with power can occur when the main rotor system is using from 20 to 100 percent of the available engine power, and the horizontal velocity is under 10 knots. At a hover, the rotor system requires a great volume of air upon which to generate lift. This air must be pulled from the surrounding air mass. This is a costly maneuver that takes a great amount of engine power.

Ground effect provides improved performance when hovering near the ground at a height of no more than approximately one-half the main rotor diameter. Translational lift is achieved at approximately 18 knots, and the rotor system receives enough free, undisturbed air to improve performance. At the instant translational lift is in effect and the hovering air-supply pattern is broken, dissymmetry of lift is created. Autorotation is a means of safely landing a helicopter after engine failure or other emergencies. A helicopter transmission is designed to allow the main rotor to turn freely in its original direction if the engine fails.



4

FLIGHT CONTROL SYSTEM

4. FLIGHT CONTROL SYSTEM

The flight control system is a hydraulically-assisted positive mechanical type, actuated by conventional helicopter controls. Complete controls are provided for both pilot and copilot. The system includes a cyclic system, collective control system, tail rotor system, force trim system, synchronized elevator, and a stabilizer bar.

4.1. Cyclic Control System

The system is operated by movement of the cyclic control stick ([Figure 4.1](#)).

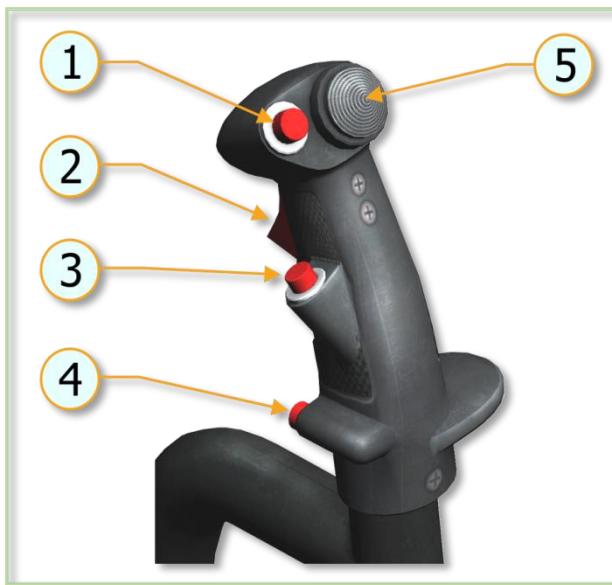

1. [Force trim switch](#)
2. Radio ICS switch
3. [Armament fire control switch](#)
4. Cargo release switch
5. Hoist switch

Figure 4.1. Cyclic Control Stick.

Moving the stick in any direction will produce a corresponding movement of the helicopter which is a result of a change in the plane of rotation of the main rotor. The pilot cyclic contains the force trim switch, radio ICS switch, armament fire control switch, cargo release switch and the hoist switch. Desired operating friction can be induced into the control stick by hand tightening the friction adjuster.

A. SYNCHRONIZED ELEVATOR. The synchronized elevator is located on the tail boom. It is connected by control tubes and mechanical linkage to the fore-and-aft cyclic system. Fore-and-aft movement of the cyclic control stick will produce a change in the synchronized elevator attitude. This improves controllability within the center of gravity (cg) range ([Figure 4.2](#)..[Figure 4.4](#)).

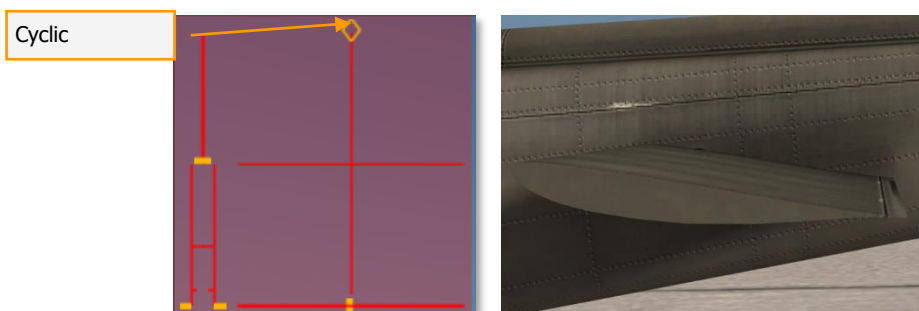

Figure 4.2. Position of the synchronized elevator when cyclic is fully forward (angle +5.40 degrees regarding the construction line of helicopter).

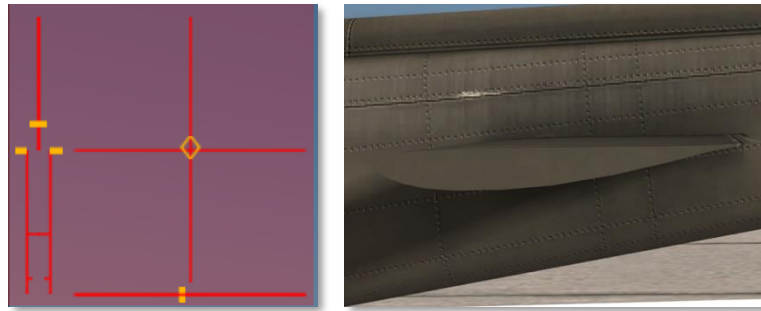

Figure 4.3. Position of the synchronized elevator when cyclic is neutral (angle -4.70 degrees).

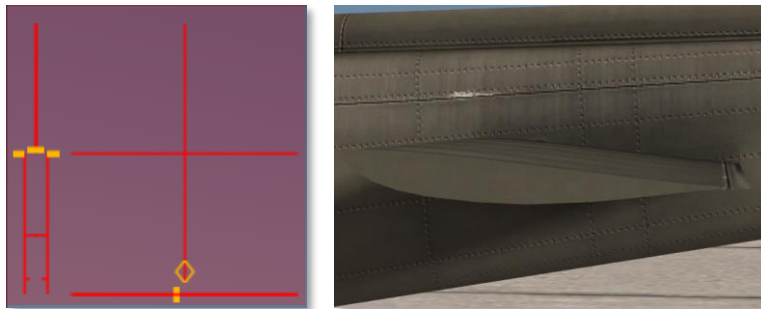

Figure 4.4. Position of the synchronized elevator when cyclic is fully back (angle +1.28 degrees).

Position of the synchronized elevator with respect to the longitudinal axis of the fuselage:

Cyclic Position	Angle	
	rad	degree
mm		
-163,8 (fully back)	0,0224	1,28
-152,5	0,0174	1,00
-127,0	0,0	0,00
-101,6	-	-1,10
-76,2	0,0192	-
-50,8	-	-2,20
-25,4	0,0384	-
0,0	-	-3,10
25,4	0,0541	-
50,8	-0,069	-3,95
76,2	-	-4,70
101,6	0,0820	-
127,0	-	-4,87
152,5	0,0850	-
163,8 (fully forward)	-	-4,60
	0,0803	-
	-	-3,60
	0,0628	-
	-0,03	-1,72
	0,0035	0,20
	0,0593	3,40
	0,0942	5,40

B. STABILIZER BAR. The stabilizer bar is mounted on the main rotor hub trunnion assembly in a parallel plane, above and at 90 degrees to the main rotor blades (Figure 4.5).

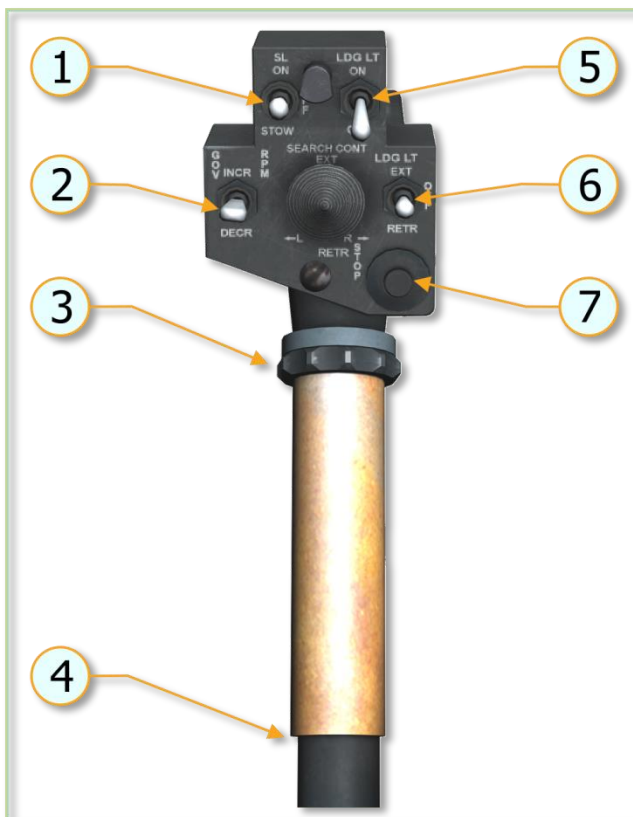

Figure 4.5. Stabilizer Bar.

The gyroscopic and inertial effect of the stabilizer bar will produce a damping force in the rotor rotating control system and thus the rotor. When an angular displacement of the helicopter/mast occurs, the bar tends to remain in its trim plane. The rate at which the bar rotational plane tends to return to a position perpendicular to the mast is controlled by the hydraulic dampers. By adjusting the dampers, positive dynamic stability can be achieved, and still allow the pilot complete responsive control of the helicopter.

4.2. Collective Control System

The collective pitch control lever controls vertical flight (Figure 4.6).



1. Searchlight switch
2. [Governor RPM switch](#)
3. Throttle friction adjuster
4. Throttle
5. Landing light ON/OFF switch
6. Landing light extend/retract switch
7. Engine idle stop release pushbutton switch

Figure 4.6. Collective Control Stick.

The amount of lever movement determines the angle of attack and lift developed by the main rotor, and results in ascent or descent of the helicopter: When the lever is in the full down position, the main rotor is at minimum pitch. When the lever is in the full up position, the main rotor is at maximum pitch. Desired operating friction can be induced into the control lever by hand-tightening the friction adjuster. A grip-type throttle and a switch box assembly are located on the upper end of the collective pitch control lever. The pilot switch box contains the starter switch, governor rpm switch, engine idle stop release switch, and landing light/searchlight switches. A collective lever down lock is located on the floor below the collective lever. The copilot collective lever contains only the grip-type throttle, governor rpm switch, and starter switch when installed. The collective pitch control system has built-in breakaway (friction) force to move the stick up from the neutral (center of travel) position of eight to ten pounds with hydraulic boost ON.

4.3. Tail Rotor Control System

The tail rotor control system is operated by pilot/copilot anti-torque pedals. Pushing a pedal will change the pitch of the tail rotor blades, resulting in directional control. Pedal adjusters are provided to adjust the pedal distance for individual comfort. A force trim system is connected to the directional controls.

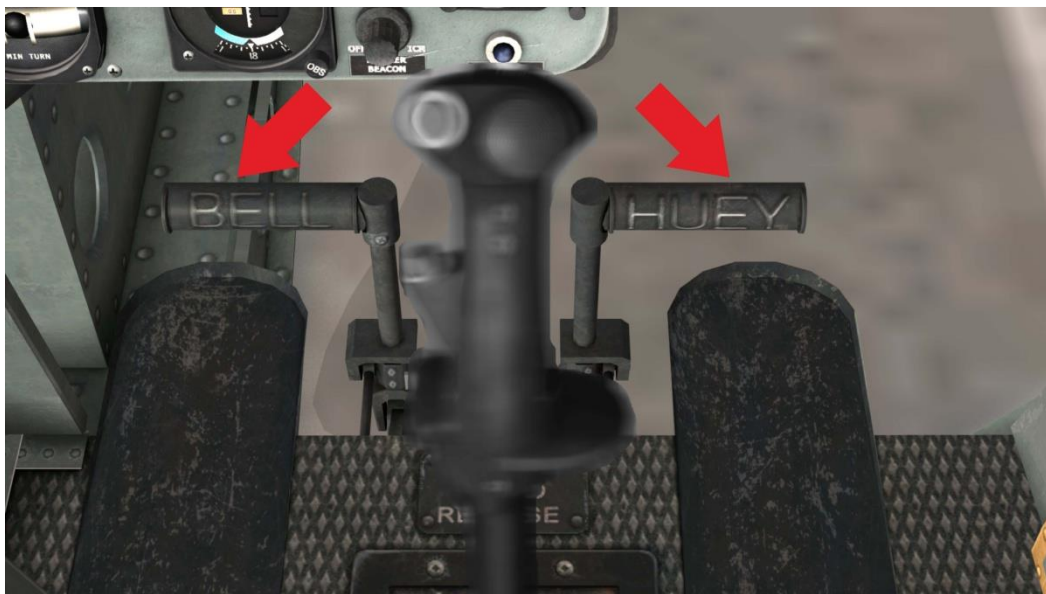

Figure 4.7. Anti-torque Pedals.

4.4. Force Trim System

Force centering devices are incorporated in the cyclic controls and directional pedal controls. These devices are installed between the cyclic stick and the hydraulic servo cylinders, and between the anti-torque pedals and the hydraulic servo cylinder. The devices furnish a force gradient or "feel" to the cyclic control stick and anti-torque pedals. A FORCE TRIM ON/OFF switch is installed on the miscellaneous control panel to turn the system on or off.



Figure 4.8. FORCE TRIM ON/OFF switch.

These forces can be reduced to zero by pressing and holding the force trim push-button switch on the [cyclic stick grip](#) (Figure 4.9) or moving the force trim switch to OFF.

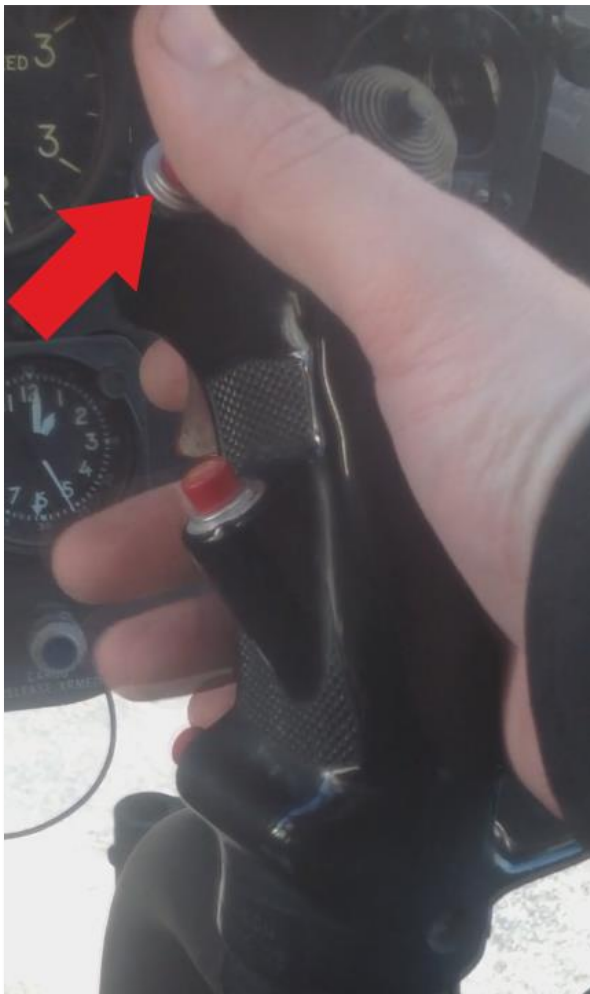

Figure 4.9. Force trim push-button switch on the cyclic stick grip.



5 COCKPIT INSTRUMENTS &

5. COCKPIT INSTRUMENTS AND CONTROLS



5.1. Instrument Panel

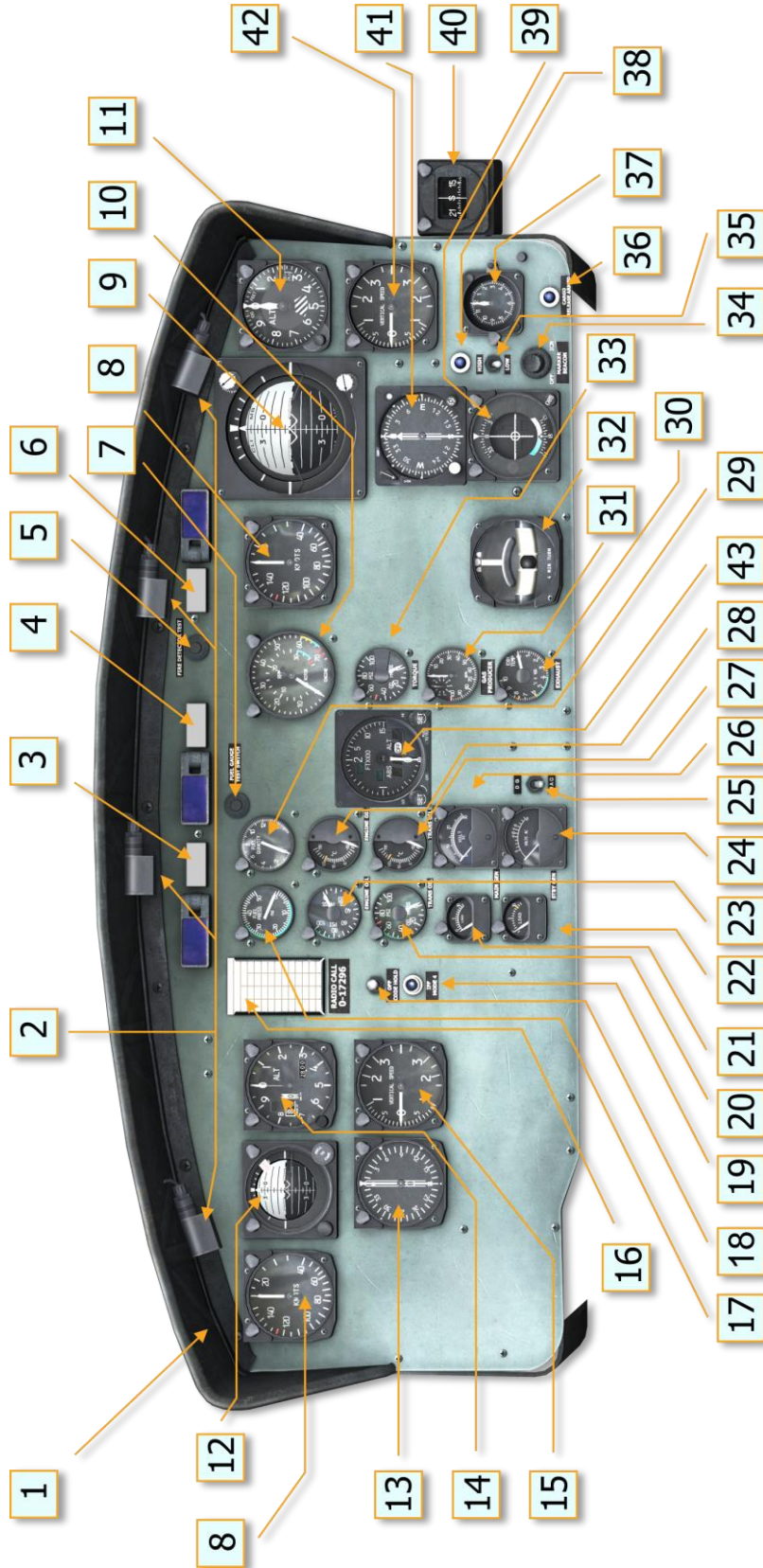

1. Glareshield
2. Secondary lights
3. [Master caution](#)
4. [RPM warning light](#)
5. [Fire detector test switch](#)
6. [Fire warning indicator light](#)
7. [Fuel gauge test switch](#)
8. [Airspeed indicator](#)
9. [Attitude indicator](#)
10. [Dual tachometer](#)
11. [Altimeter indicator \(AAU-31/A\)](#)
12. [Attitude indicator](#)
13. [Radio compass indicator](#)
17. [Fuel pressure indicator](#)
18. [IFF code hold switch](#)
19. [IFF code hold light](#)
20. [Transmission oil pressure indicator](#)
21. [Main generator loadmeter](#)
22. [Standby generator loadmeter](#)
23. [Engine oil pressure indicator](#)
24. [AC voltmeter](#)
25. [Compass slaving switch](#)
26. [DC voltmeter](#)
27. [Transmission oil](#)
31. [Gas producer tachometer indicator](#)
32. [Turn and slip indicator](#)
33. [Torquemeter indicator](#)
34. [Marker beacon volume control](#)
35. [Marker beacon Sensing Switch](#)
36. [Cargo release armed light](#)
37. [Clock](#)
38. [Marker beacon light](#)
39. [Course deviation indicator](#)
40. [Magnetic compass](#)

Figure 5.1. UH-1H instrument panel.

- | | | |
|--|---|---|
| 14. Altimeter indicator (AAU-32/A) | temperature indicator | 41. Radio compass indicator |
| 15. Vertical velocity indicator | 28. Engine oil temperature | 42. Vertical velocity indicator |
| 16. Compass correction card holder | 29. Fuel quantity indicator | 43. Radar altimeter |
| | 30. Exhaust gas temperature indicator | |

Figure 5.1. UH-1H instrument panel description.

5.1.1. Master Caution System

- a) Master Caution Indicator. The master caution indicator light on the instrument panel will illuminate when fault conditions occur. This illumination alerts the pilot and copilot to check the [caution panel](#) for the specific fault condition.



- b) [Caution panel](#). The CAUTION panel is located on the pilot side of the pedestal ([Figure 5.2](#)). Worded segments illuminate to identify specific fault conditions. The worded segments are readable only when the light illuminates. When a light illuminates, flickers or full illumination, it indicates a fault condition. Refer to [Caution Lights Panel](#) for explanation of the fault conditions.

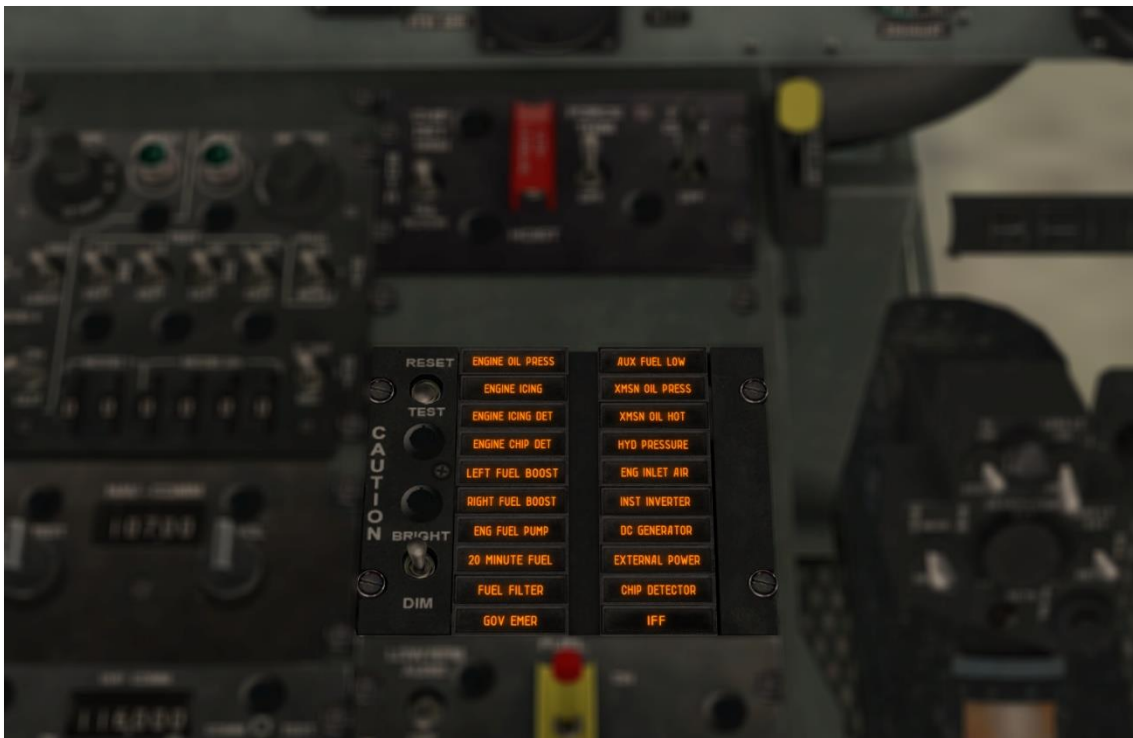

Figure 5.2. CAUTION panel location.

- c) Electrical Power. Electric power for the master caution system is supplied from the essential bus. Circuit protection is provided by the CAUTION LIGHTS circuit breakers.

5.1.2. RPM High-Low Limit Warning System ([4](#), [Figure 5.1](#))

The rpm high-low limit warning system provides the pilot with an immediate warning of high and low rotor or engine rpm. Main components of the system are a detector unit, warning light and audio signal circuit, low RPM AUDIO/OFF switch, and electrical wiring and connectors. The warning light and audio warning signal systems are activated when any one of the following rpm conditions exist:

a) Warning light only:



- (1) For rotor rpm of 329-339 (High Warning).
- (2) For rotor rpm of 300-310 (Low Warning).
- (3) For engine rpm of 6100-6300 (Low Warning).
- (4) Loss of signal (circuit failure) from either rotor tachometer generator or power turbine tachometer generator.

b) Warning light and audio warning signal combination:

- (1) For rotor rpm of 300-310 and engine rpm of 6100-6300 (Low Warning).
- (2) Loss of signal (circuit failure) from both rotor tachometer generator and power turbine tachometer generator.

c) Rotor Tachometer Generator and Power Turbine Tachometer Generator. The rotor tachometer generator and power turbine tachometer generator both send signals to the high-low rpm warning light and audio warning circuits. When only the warning light is energized, determine the cause of indication by checking the torquemeter and cross referencing other engine instruments. A normal indication signifies that the engine is functioning properly and that there is a tachometer generator failure or an open circuit to the warning system rather than an actual engine failure. Electrical power for system operation is supplied by the 28 VDC essential bus.

d) High-Low Limit RPM Warning Light. The high-low warning light is located on the instrument panel. This light illuminates to provide a visual warning of low rotor rpm, low engine rpm or high rotor rpm.

e) LOW RPM AUDIO/OFF Switch. The LOW RPM AUDIO/OFF switch is on the [engine control panel](#). When in the OFF position, the switch prevents the audio warning signal from functioning during engine starting. Current production helicopters use a spring-loaded switch. When the switch has been manually turned off for engine starting, it will automatically return to the AUDIO position when normal operating range is reached.

5.1.3. Fire Detector Warning System (5, 6, Figure 5.1).

A FIRE warning light is located in the upper right section of the instrument panel. The FIRE DETECTOR TEST switch (press to test) is located to the left of the fire warning light.



Excessive heat in the engine compartment causes the FIRE light to illuminate. Pressing the press-to-test switch also causes the light to illuminate. Electric power for the circuit is supplied from the 28 VDC essential bus and is protected by the FIRE DET circuit breaker. [Back to instrument panel](#)

5.1.4. Airspeed indicator (8, Figure 5.1)



The pilot and copilot airspeed indicators display indicated airspeed (IAS) in knots. The gauge is graduated from 0 to 150 knots in either 5 or 10 knot increments depending on the airspeed. The indicator is red lined at 124 knots.

Note. Indicated airspeeds are unreliable below 20 knots due to rotor downwash

5.1.5. Attitude Indicators ([9](#), [12](#), [Figure 5.1](#))

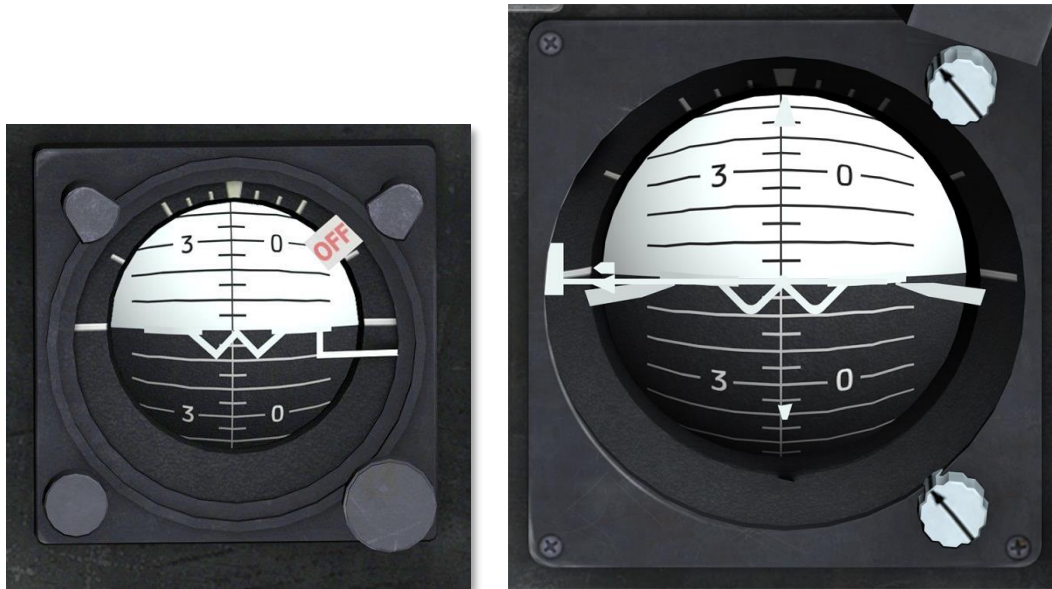

Figure 5.3. Attitude Indicator (AI) copilot (left) and pilot (right).

The Attitude Indicator (AI) provides your primary instrument indication of aircraft pitch, roll and yaw in relation to an artificial horizon represented on a sphere. [Back to instrument panel](#)

A. Copilot Attitude Indicator

The copilot attitude indicator is located in the copilot section of the instrument panel. It is operated by 115 VAC power supplied by the inverter. Circuit protection is provided by the COPILOT ATTD circuit breakers in the AC circuit breaker panel. In a climb or dive exceeding 27 degrees of pitch, the horizontal bar will stop at the top or bottom of the case and the sphere then becomes the reference. The copilot attitude indicator may be caged manually by pulling the PULL TO CAGE knob smoothly away from the face of the instrument to the limit of its travel and then releasing quickly.

Note. The copilot attitude indicator shall be caged only in a straight and level attitude. The caging knob shall never be pulled violently.

B. Pilot Attitude Indicator.

The pilot attitude indicator is located on the pilot section of the instrument panel. The indicator displays the pitch and roll attitude of the helicopter. An OFF warning flag in the indicator is exposed when electrical power to the system is removed. However, the OFF flag will not indicate internal system failure. The attitude indicator has an electrical trim in the roll axis in addition to the standard pitch trim. The attitude indicator is operated by 115 VAC power, supplied by the inverter. Circuit protection is provided by the PILOT ATTD circuit breakers in the AC circuit breaker panel.

5.1.6. Dual tachometer ([10](#), Figure 5.1)

The dual tachometer is located in the center area of the instrument panel and indicates both the engine and main rotor rpm. The tachometer inner scale (2) is marked ROTOR and the outer scale (1) is marked ENGINE. Synchronization of the ENGINE and ROTOR needles indicates normal operation of helicopter. The indicator receives power from the tachometer generators mounted on the engine and transmission. Connection to the helicopter electrical system is not required. [Back to instrument panel](#)

[Back to Engine Instrument and Indicators](#)



11. Revolutions of power turbine
(outer scale, x100)

22. Revolutions of main rotor
(inner scale, x10)

5.1.7. Altimeter Indicator (AAU-31/A)([11](#), Figure 5.1)



A. Description

The AAU-31/A pneumatic counter-drum-pointer altimeter is a precision pressure altimeter. Pressure altitude is displayed by a 100-foot drum and a single pointer indicating hundreds of feet on a circular scale, with 50' center markings. Below an altitude of 10,000 feet, a diagonal warning symbol will appear on the 10,000-foot counter.

A barometric pressure setting knob is provided to set the desired altimeter setting in inches of Mercury (inHg). A DC powered vibrator operates inside the altimeter whenever aircraft power is on.

B. Normal operation

The altimeter indicates pneumatic altitude reference to the barometric pressure level as selected by the pilot. A vibrator, powered by the DC essential bus, is contained in the altimeter and requires a minimum of one minute warmup prior to checking or setting the altimeter.

C. Abnormal operation

If the altimeter's internal vibrator becomes inoperative due to internal failure or DC power failure, the pointer and drum may momentarily hang up when passing from "9" through "0" (climbing) or from "0" through "9" (descending). This hang-up will cause lag, the magnitude of which will depend on the vertical velocity of the aircraft and the friction in the altimeter. Pilots should be especially watchful for this type of failure when the minimum approach altitude lies within the "8" – "1" part of the scale (800-1100, 1800-2100, etc.). [Back to instrument panel](#)

5.1.8. Radio compass indicator (copilot) ([12](#), Figure 5.1)

The copilot's Radio Compass Indicator is a repeater of the pilot's indicator, described below.

5.1.9. Radio Compass Indicator ([41](#), Figure 5.1)



A. Description

A radio magnetic indicator is installed in the pilot instrument panel. A second radio magnetic indicator (not shown) is installed in the copilot's instrument panel. The copilot indicator is a repeater type instrument similar to the pilot indicator except that it has no control knobs. The moving compass card on both indicators displays the geomagnetic compass heading. The number 1 pointer on the indicators indicate the bearing to the NDB or course to the VOR station. The number 2 pointer indicates the VOR course to the station.

B. Operation

- (1) INV switch – MAIN or STBY.
- (2) Radio magnetic indicator (pilot only) – Check power failure indicator is not in view.

SLAVED GYRO MODE.

- (3) COMPASS switch – MAG (see [5.1.19](#)).
- (4) Synchronizing knob – Center (Null) annunciator.
- (5) Magnetic heading – Check.

FREE GYRO MODE.

- (6) COMPASS switch – DG (see [5.1.19](#)).
- (7) Synchronizing knob – Set heading.
- (8) Annunciator – Center position and then does not change (Annunciator is de-energized in the free gyro (DG) mode).

C. Inflight operation.

Set the COMPASS switch to MAG or DG as desired for magnetically slaved or free gyro mode of operation. Free gyro (DG) mode is recommended when flying in latitudes higher than 70 degrees. [Back to instrument panel](#)

When operated in the slaved (MAG) mode, the system will remain synchronized during normal flight maneuvers. During violent maneuvers the system may become unsynchronized, as indicated by the annunciator moving off center. The system will slowly remove all errors in synchronization, however, if fast synchronization is desired, turn the synchronizing knob in the direction indicated by the annunciator until the annunciator is centered again.

When operating in the free gyro (DG) mode, periodically update the heading to a known reference by rotating the synchronizing knob.

[Back to instrument panel](#)

5.1.10. Altimeter indicator (AAU-32/A) ([14](#), Figure 5.1)



A. Description

The AAU-32/A pneumatic counter-drum-pointer altimeter is a self-contained unit which consists of a precision pressure altimeter combined with an altitude encoder. The display indicates and the encoder transmits. Simultaneously, pressure altitude is displayed on the altimeter by a 10,000-foot counter, a 1,000-foot counter and a 100-foot drum. A single pointer indicates hundreds of feet on a circular scale, with 50-foot center markings. Below an altitude of 10,000 feet, a diagonal warning system will appear on the 10,000-foot counter. A barometric pressure setting knob is provided to set the desired altimeter setting in inches of Mercury (inHg).

B. Normal Operation

The AIMS altimeter circuit breaker should be closed prior to flight. The AAU-32/A altimeter indicates pneumatic altitude reference to the barometric pressure level as selected by the pilot. At ambient pressure, altimeters should agree with ± 70 feet of the field elevation when the proper barometric pressure setting is set in the altimeter. A red flag marked CODE OFF is located in the upper left portion of the altimeters face. In order to supply Mode C information to the IFF transponder, the CODE OFF flag must not be visible. A vibrator, powered by the DC essential bus, is contained in the altimeter and requires a minimum of one minute warm-up prior to checking or setting the altimeter.

C. Abnormal Operation

If the altimeter's internal vibrator becomes inoperative due to internal failure or DC power failure, the pointer and drum may momentarily hang up when passing from "9" through "0" (climbing) or from "0" through "9" (descending). This hang-up will cause lag, the magnitude of which will depend on the vertical velocity of the aircraft and the friction in the altimeter. Pilots should be especially watchful for this type failure when the minimum approach altitude lies within the "8" – "1" part of the scale (800-1100, 1800-2100, etc).

If the CODE OFF flag is visible, the DC power is not available, the circuit breaker is not in, or there is an internal altimeter encoder failure.

If the altimeter indicator does not correspond within 70 feet of the field elevation (with proper local barometric setting) the altimeter needs rezeroing or there has been an internal failure.

If the baroset knob binds or sticks, abnormal force should not be used to make the setting as this may cause internal gear failure resulting in altitude errors. Settings can sometimes be made by backing off and turning at a slower rate.
[Back to instrument panel](#)

5.1.11. Vertical velocity indicator ([15, 42](#), Figure 5.1)

The VVI displays rate of climb or descent in increments of feet per minute. The scale is in increments of 1000 feet per min.



[Back to instrument panel](#)

5.1.12. Fuel Pressure Indicator ([17](#), Figure 5.1)

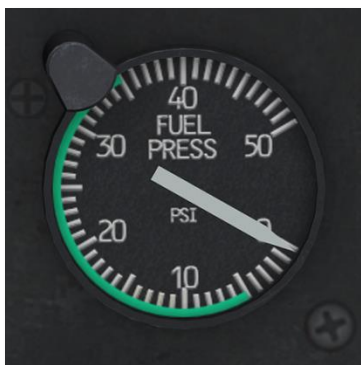

Reading of the instrument: 5 to 35 PSI normal.

The Fuel Pressure indicator displays the pounds per square inch (PSI) pressure of the fuel being delivered by the boost pumps from the fuel cells to the engine. The indicator is graduated from 0 to 50 PSI in single PSI increments.

The circuit receives power from the 28 VAC bus and is protected by the FUEL PRESSURE circuit breaker in the AC circuit breaker panel.

5.1.13. IFF code hold switch

Not implemented in DCS: UH-1H Huey.

5.1.14. IFF code hold light

Not implemented in DCS: UH-1H Huey.

5.1.15. Transmission oil pressure ([20](#), [Figure 5.1](#))

Reading of the instrument: 30 PSI minimum, 40-60 PSI continuous, 70 PSI maximum.



The TRANS OIL pressure indicator is located in the center area of the instrument panel. It displays the transmission oil pressure in pounds per square inch (PSI).

Electrical power for the circuit is supplied from the 28 VAC bus and is protected by the XMSN circuit breaker in the AC circuit breaker panel.

[Back to instrument panel](#)

5.1.16. DC Loadmeters (Main and Standby) ([21](#), [22](#), [Figure 5.1](#))



Two direct current loadmeters are mounted in the lower center area of the instrument panel. The MAIN GEN loadmeter indicates the percentage of main generator rated capacity being used. The STBY GEN loadmeter indicates the percentage of standby generator rated capacity being used. The loadmeters will not indicate percentage when the generators are not operating.

Reading of the instrument: Main generator 1.0 to 1.25 transient, standby generator 1.0 maximum (red).

5.1.17. Engine oil pressure indicator ([23](#), Figure 5.1)



[Back to Engine Instrument and Indicators](#)

The Engine Oil Pressure indicator is located in the center area of the instrument panel and is marked OIL PRESS. The indicator receives pressure indications from the engine oil pressure transmitter and provides readings in pounds per square inch (PSI).

The circuit receives electrical power from the 28 VAC bus and circuit protection is provided by the ENG circuit breaker in the AC circuit breaker panel.

Reading of the instrument: 25 PSI minimum – engine idle (red), 80 to 100 PSI normal (green), 100 PSI maximum (red).

5.1.18. AC voltmeter ([24](#), Figure 5.1)



[Back to instrument panel](#)

The AC voltmeter is mounted on the center area of the instrument panel. The AC voltage output from the inverter (main or spare) is indicated on this instrument. The voltage indicated on any of the three selected positions should be 112 to 118 VAC.

5.1.19. Compass slaving switch ([25](#), Figure 5.1)



COMPASS switch – DG / MAG:

DG – providing Free gyro mode, MAG – providing Slaved gyro mode.
(see [5.1.9](#))

5.1.20. DC voltmeter ([26](#), Figure 5.1)



The DC voltmeter is located in the center area of the instrument panel and is labeled VOLT DC. Direct current voltage is indicated on the voltmeter as selected by the VM switch in the overhead console.

5.1.21. Transmission oil temperature indicator ([27](#), Figure 5.1)

Transmission oil temperature: maximum 110°C.

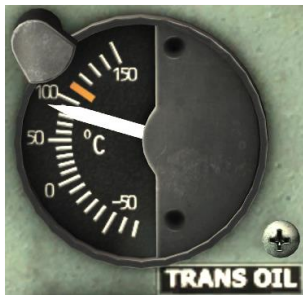

The transmission oil temperature indicator is located in the center area of the instrument panel. The indicator displays the temperature of the transmission oil in degrees Celsius.

The electrical circuit receives power from the essential bus and is protected by the TEMP IND ENG & XMSN circuit breaker in the DC circuit breaker panel. This is a wet bulb system dependent on fluid for valid indication.

[Back to instrument panel](#)

5.1.22. Engine oil temperature ([28](#), Figure 5.1)



[Back to Engine Instrument and Indicators](#)

The Engine Oil Temperature indicator is located in the center area of the instrument panel and is marked ENGINE OIL. The temperature of the engine oil at the engine oil inlet is indicated in degrees Celsius.

The maximum temperature is 93°C below 30°C FAT, 100°C at 30°C FAT and above.

Power to operate the circuit is supplied from the 28 VDC essential bus. Circuit protection is provided by the TEMP IND ENG & XMSN circuit breaker.

5.1.23. Fuel Quantity Indicator ([29](#), Figure 5.1)



The Fuel Quantity indicator is located in the upper center area of the instrument panel. This instrument continuously indicates the quantity of fuel in pounds. The indicator is connected to three fuel transmitters mounted in the fuel cells. Two are mounted in the right forward cell and one in the center aft cell. Indicator readings shall be multiplied by 100 to obtain fuel quantity in pounds.

Electrical power for operation is supplied from the 115 VAC system and is protected by circuit breaker FUEL QTY in the AC circuit breaker panel.

5.1.24. Exhaust gas temperature indicator ([30](#), Figure 5.1)



[Back to instrument panel](#)

[Back to Engine Instrument and Indicators](#)

The exhaust gas temperature indicator is located in the center area of the instrument panel and is marked EXH TEMP. The indicator receives temperature indications from the thermocouple probes mounted in the engine exhaust diffuser section. The temperature indications are in degrees celsius. The system is electrically self-generating.

The indicator is marked as follows:

- 400°C to 610°C Continuous (green)
- 610°C to 625°C 30 Minutes (red)
- 625°C maximum 30 Minutes
- 625°C to 675°C 10 Second Limit for Starting and Acceleration
- 675°C to 760°C 5 Second Limit for Starting and Acceleration

- 760°C Maximum gas temperature (red)

5.1.25. Gas Producer Tachometer Indicator ([31](#), Figure 5.1)

The maximum rpm of the gas producer turbine speed is 101.5 percent (red).



[Back to Engine Instrument and Indicators](#)

The gas producer indicator is located in the right center area of the instrument panel and is marked RPM GAS PRODUCER. The indicator displays the rpm of the gas producer turbine speed in percent. This system receives power from a tachometer generator which is geared to the engine compressor. A connection to the helicopter electrical system is not required.

5.1.26. Turn and slip indicator ([32](#), Figure 5.1)



[Back to instrument panel](#)

The turn and slip indicator displays the helicopter slip condition, direction of turn and rate of turn. The ball displays the slip condition. The pointer displays the direction and rate of the turn.

To maintain coordinated flight, the pilot uses the pointer to maintain heading, while using the anti-torque pedals to counteract any slip and keep the ball centered. Remember, to maintain coordinated flight, "step on the ball."

5.1.27. Torquemeter Indicator ([33](#), Figure 5.1)

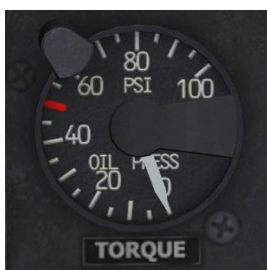

[Back to Engine Instrument and Indicators](#)

The torquemeter indicator is located in the center area of the instrument panel and is marked OIL PRESS. The indicator is connected to a transmitter which is part of the engine oil system. The torquemeter indicates torque in pounds per square inch (PSI) of torque imposed upon the engine output shaft. The indicator is marked with the maximum torque limit for each engine as reflected by the individual engine Data Plate Torque (50 PSI in this case).

The torquemeter receives power from the 28 VAC bus and is protected by a circuit breaker marked TORQUE in the AC circuit breaker panel.

5.1.28. Marker beacon volume control

Turns the set on/off and adjusts audio signal volume.

5.1.29. Marker beacon sensing switch ([35](#), Figure 5.1)

The marker beacon sensing switch controls the sensitivity of the marker beacon receiver between HIGH and LOW settings.

5.1.30. Cargo release armed light ([36](#), Figure 5.1)

This light illuminates when the CARGO RELEASE switch is set to ARM.

5.1.31. Clock ([37](#), Figure 5.1)



[Back to instrument panel](#)

Standard clock. The time can be adjusted by left-clicking over the adjust knob to pull it out and rotating the mouse wheel over it to set the time.

5.1.32. Marker beacon light

The marker beacon light flashes when the marker beacon receiver is operating and the aircraft is passing over a ground marker transmitter.

5.1.33. Course deviation indicator ([39](#), Figure 5.1)

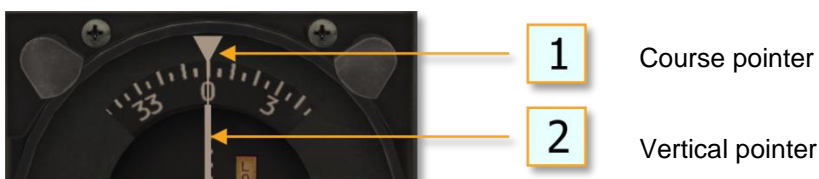

Horizontal pointer

Reciprocal pointer

Course selector knob

A. Description.

The Navigation Receiver set provides reception on 200 channels, with 50 kHz spacing between 108.0 and 126.95 MHz. This permits reception of the VHF omnidirectional range (VOR) between 108.0 and 117.95 MHz. The Localizers are received on odd-tenth MHz, between 108.0 and 112.0 MHz and energized as selected. Both VOR and Localizer are received aurally through the interphone system. The VOR is presented visually by the course indicator and the number 2 pointer on the bearing indicator and the localizer is presented visually by the vertical needle on the course deviation indicator (CDI). When the R-1963/ARN Glideslope/Marker Beacon Receiver is installed, the glide slope frequency is selected by tuning an associated localizer frequency on the control panel.

B. Controls and Functions.

CONTROL/INDICATOR	FUNCTION
VOL control	Controls receiver audio volume.
Power switch	Turns primary power to the radio set and to the R-1963/ARN Marker Beacon/Glideslope Receiver ON or OFF. Allows for accuracy of Course Deviation Indicators and Marker Beacon indicator lamp in the TEST position.
Whole megahertz channel selector knob	This is the control knob on the left side. It is used to select the whole megahertz number of the desired frequency.
Fractional megahertz channel selector knob	This is the control knob on the right side. It is used to select the fractional megahertz number of the desired frequency.

[Back to instrument panel](#)



C. Operation.

- (1) Function switch – PWR.
- (2) RECEIVERS NAV switch – ON.
- (3) Frequency – Select.
- (4) VOL – Adjust.

INDICATOR	FUNCTION
OFF vertical	Disappears when FM homing circuits are functioning properly. Remains in view when FM homing circuits are not functioning properly.
OFF horizontal flag	Disappears when homing circuits are functioning properly. Remains in view when FM homing circuits are not functioning properly. NOTE: Do not use if either OFF flag is in view.
Horizontal pointer	Indicates strength of FM homing signal being received. Deflects downward as signal strength decreases.
Vertical (reciprocal) pointer	Indicates when pointer is centered that helicopter is flying directly toward or away from the station. Deflection of the pointer indicates the direction (right or left) to turn to fly to the station.

5.1.34. Standby magnetic compass ([40](#), Figure 5.1)



The standby (magnetic) compass is mounted in a bracket at the center right edge of the instrument panel. A deviation in magnetic compass indications will occur when the landing light, searchlights, or pitot heat are turned on.

[Back to instrument panel](#)

5.1.35. Radar Altimeter - AN/APN-209 (43, Figure 5.1. UH-1H instrument panel.



Figure 5.4. AN/APN-209 radar altimeter

A. Description.

The radar altimeter is a short pulse, terrain tracking and altitude sensing radar system that measures and visually indicates by pointer and digital display actual clearance in feet between the helicopter and terrain over a range from 0 to 1500 feet. The system provides an accurate indication of altitude of the aircraft over all types of terrain surfaces such as foliage, deep snow, water, and land. The indicator provides precise altitude indications with a manually set low-level and high-level warning flag to warn when a predetermined low or high altitude limit has been reached.

For altitudes up to 250 feet, the accuracy of the AN/APN-209 is plus or minus 3 feet plus 3% of true altitude. The AN/APN-209 operates within a frequency range of 4200 MHz to 4400 MHz and will provide reliable operation at all speeds up to 300 knots on the ground over any terrain. Input power requirement is 27.5 volts DC at 2 amperes maximum.

B. Controls and Functions.

CONTROL/INDICATOR	FUNCTION
1. LO SET control knob	Turns facility on and off, and sets low limit index.
2. LO level warning flag	Indicates LO when altitude pointer indicates below low limit index.
3. Low limit index	Indicates low altitude limit index setting. Actuates LO level warning flag when limit is reached.
4. Hi level warning flag	Indicates HI when altitude pointer indicates above high limit index.
5. High limit index	Indicates high altitude limit index. Actuates HI level warning flag when limit is reached.

6. Altitude pointer	Indicates actual altitude in feet from helicopter to terrain (zero to 1500 feet).
7. HI SET control knob	Sets high altitude limit index and actuates self-test mode.

C. Operation.

- (1) LO SET control knob – TURN the knob clockwise (AN/APN-209 will be ON).
- (2) HI SET control knob – PUSH for test.
- (3) LO and HI SET control knob – SET low and high limit altitude.

5.2. Pedestal Control Panels

5.2.1. Miscellaneous Control Panel



HYDRAULIC CONTROL SWITCH. When set to ON, pressure is supplied to the hydraulic servo system. When set to OFF, the solenoid valve is closed and no pressure is supplied to the servo system.

FORCE TRIM SWITCH. Turns the force trim system ON/OFF.

CABLE CUT SWITCH. Used for emergency release of the hoist cable.

CHIP DET (DETECTOR) SWITCH. The switch is labeled BOTH, XMSN, and TAIL ROTOR and is spring-loaded to the BOTH position. When the CHIP DETECTOR segment in the caution panel lights up, position the switch to XMSN, then TAIL ROTOR to determine the trouble area. CHIP DET caution light will remain on when a contaminated component is selected. The light will go out if the non-contaminated component is selected.

5.2.2. Caution Lights Panel

The Caution Lights Panel is subsystem of the [Master Caution System](#).

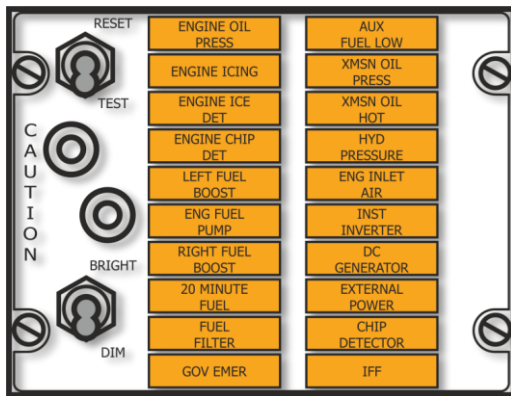

ENGINE OIL PRESS	Engine oil pressure below 25 psi
*ENGINE ICING	Engine Icing detected
*ENGINE ICE DET	Not connected
ENGINE CHIP DET	Metal particle in engine oil
LEFT FUEL BOOST	Left fuel boost pump inoperative
RIGHT FUEL BOOST	Right fuel boost pump inoperative
ENG FUEL PUMP	Engine fuel pump inoperative
20 MINUTE	Fuel quantity about 170 lbs
FUEL FILTER	Fuel filter Impending bypass <i>not implemented in DCS: UH-1H</i>
*GOV EMER	Governor switch in emergency position
AUX FUEL LOW	Auxiliary fuel tank empty
XMSN OIL PRESS	Transmission oil pressure below 30 psi
XMSN OIL HOT	Transmission oil temperature above 110°C
HYD PRESSURE	Hydraulic pressure Low
*ENGINE INLET AIR	Engine air filter clogged <i>not implemented in DCS: UH-1H</i>
INST INVERTER	Failure of inverter
DC GENERATOR	DC Generator failure
EXTERNAL POWER	External power access door open
CHIP DETECTOR	Metal particles present in 42° or 90° gearbox or main transmission
*IFF	IFF System inoperative

[Back to Engine Instrument and Indicators](#)

A. BRIGHT-DIM SWITCH. The BRIGHT-DIM switch on the CAUTION panel permits the pilot to manually select a bright or dimmed condition for all the individual worded segments and the master caution indicator. The dimming switch position will work only when the pilot instrument lights are on. The master caution system lights will be in bright illumination after each initial application of

electrical power, when the pilot instrument lights are turned OFF, or a loss of power from the DC essential bus occurs.

B. RESET-TEST SWITCH. The RESET-TEST switch on the CAUTION panel enables the pilot to manually reset and test the master caution system. Momentarily placing the switch in the RESET position, extinguishes and resets the master caution indicator light so it will again illuminate should another fault condition occur. Momentarily placing the switch in TEST position will cause the illumination of all the individually worded segments and the master caution indicator. Only the lamp circuitry is tested; the condition circuitry is not. Testing of the system will not change any particular combination of fault indications which might exist prior to testing. The worded segments will remain illuminated as long as fault condition or conditions exist, unless the segment is rotated.

5.2.3. Engine Control Panel

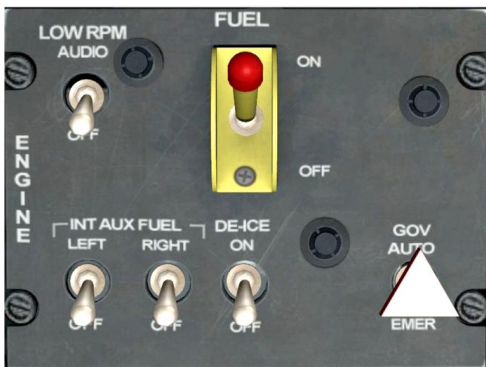

MAIN FUEL SWITCH. The switch is protected from accidental operation by a spring-loaded toggle head that must be pulled up before switch movement can be accomplished. When the switch is in the ON position, the fuel valve opens, the electric boost pump(s) are energized and fuel flows to the engine. When the switch is in the OFF position, the fuel valve closes and the electric boost pump(s) are de-energized ([see also 6.1.1](#)).

Electrical power for circuit operation is supplied by the 28 VDC essential bus and is protected by circuit breakers FUEL VALVES, LH BOOST PUMP and RH BOOST PUMP.

LOW RPM AUDIO SWITCH. This switch enables/disables the Low RPM audio warning tone, which operates in conjunction with the Low [RPM warning light](#). When enabled, the audio tone is heard under the following conditions:

- a) For rotor rpm of 300-310 and engine rpm of 6100-6300 (Low Warning).
- b) Loss of signal (circuit failure) from both rotor tachometer generator and power turbine tachometer generator.

GOV (GOVERNOR) SWITCH. AUTO position permits the overspeed governor to automatically control the engine rpm with the throttle in the full open position. The EMER position permits the pilot or copilot to manually control the rpm (see [Engine Fuel Control System](#)). [To CAUTION LIGHTS PANEL](#)

The governor circuit receives power from the 28 VDC essential bus and is protected by the GOV CONT circuit breaker.

ENGINE DE-ICE SWITCH. Engine de-ice is a bleed air system. In the ON position, bleed air is directed through the engine inlet to provide protection. Use of this system will result in reduced available engine power. In the event of DC electrical failure or when the DE-ICE ENG circuit breaker is out, de-ice is automatically ON.

System power is provided by the DC essential bus and protected by the ANTI-ICE ENG circuit breaker.

INTERNAL FUEL TRANSFER SWITCHES. (NOT IMPLEMENTED IN DCS: UH-1H) Two switches marked INT AUX FUEL LEFT/RIGHT are mounted on the ENGINE control panel. Placing the switches to the forward position energizes the auxiliary fuel system. Fuel is transferred to the main fuel cells. An overfill limit switch is installed in the main fuel tank to prevent the auxiliary fuel pumps from overflowing the main fuel cells.

Power is supplied by the DC essential bus and protected by the FUEL TRANS PUMP circuit breaker.

5.3. Overhead Console

The location of the controls and circuit breakers installed in the overhead console is depicted in Figure 5.5.



Figure 5.5. Overhead Console.



6 HELICOPTER SYSTEMS

6. HELICOPTER SYSTEMS

6.1. Helicopter fuel system

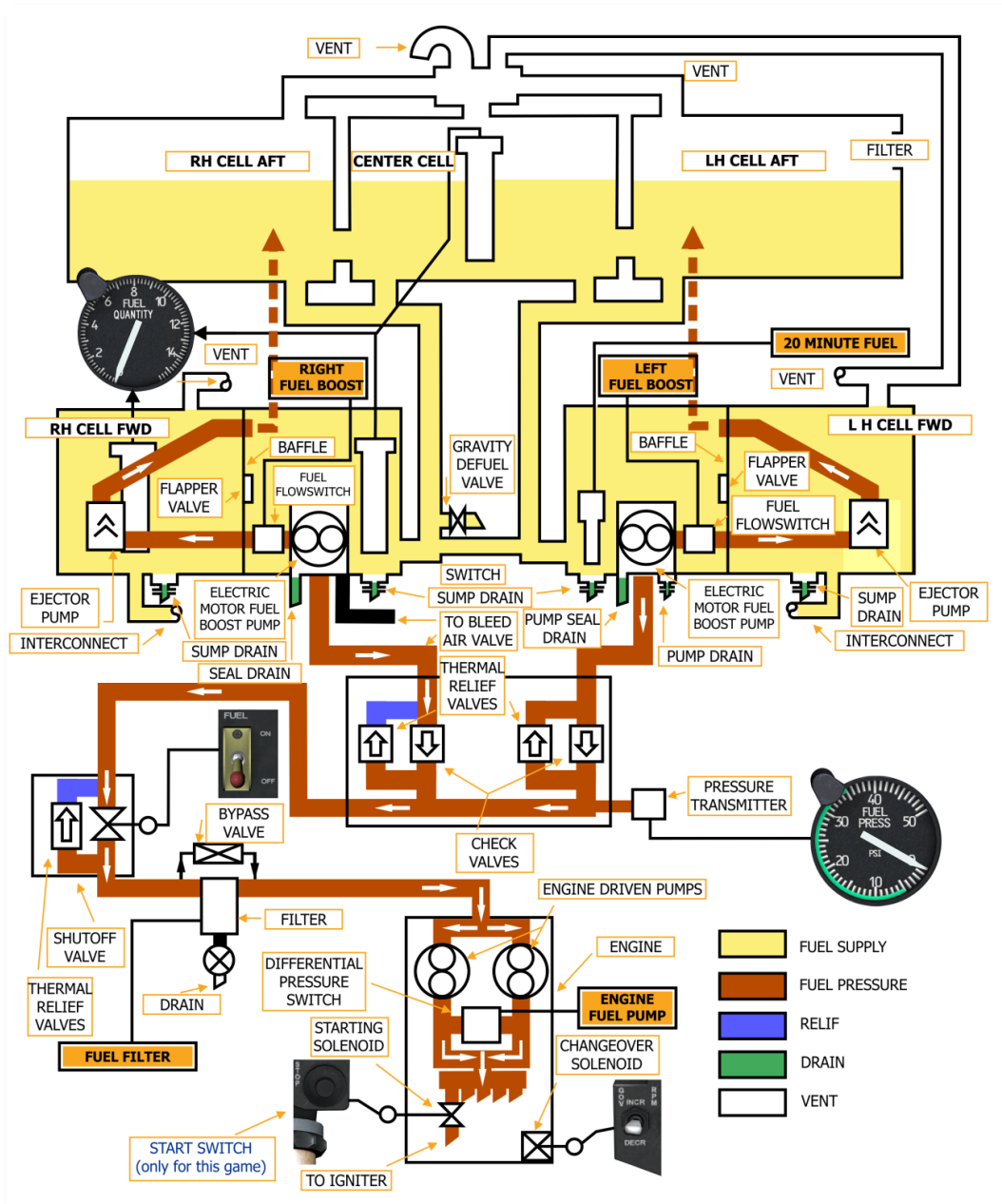

Figure 6.1. Fuel system schematic.

6.1.1. Controls and Indicators

A. *FUEL SWITCHES.* The fuel system switches consist of a main fuel switch:

- a) **Main Fuel Switch.** The FUEL MAIN ON/OFF switch is located on the pedestal-mounted ENGINE panel. The switch is protected from accidental operation by a spring-loaded toggle head that must be pulled up before switch movement can be accomplished. When the switch is in the ON position, the fuel valve opens, the electric boost pump(s) are energized and fuel flows to the engine. When the switch

is in the OFF position, the fuel valve closes and the electric boost pump(s) are de-energized. Electrical power for circuit operation is supplied by the 28 VDC essential bus and is protected by circuit breakers FUEL VALVES, LH BOOST PUMP and RH BOOST PUMP.

- b) Fuel Control. Fuel flow and mode of operation is controlled by switches on the pedestal-mounted [engine control panel](#). The panel contains the MAIN FUEL ON/OFF and GOV AUTO/EMER switch. The switch over to emergency mode is accomplished by retarding the throttle to idle or off position and positioning the GOV AUTO/EMER switch to the EMER position. In the EMER position fuel is manually metered to the engine, with no automatic control features, by rotating the throttle twist grip.

B. FUEL QUANTITY INDICATOR. The [fuel quantity indicator](#) is located in the upper center area of the instrument panel. This instrument is a transistorized electrical receiver which continuously indicates the quantity of fuel in pounds. The indicator is connected to three fuel transmitters mounted in the fuel cells. Two are mounted in the right forward cell and one in the center aft cell. Indicator readings shall be multiplied by 100 to obtain fuel quantity in pounds. Electrical power for operation is supplied from the 115 VAC system and is protected by circuit breaker FUEL QTY in the AC circuit breaker panel.

C. FUEL GAUGE TEST SWITCH. The [FUEL GAUGE TEST switch](#) (7, Figure 5.1) is used to test the fuel quantity indicator operation. Pressing the switch will cause the indicator pointer to move from the actual reading to a lesser reading. Releasing the switch will cause the pointer to return to the actual reading. The circuit receives power from the 115 VAC system and is protected by a circuit breaker marked FUEL QTY in the AC circuit breaker panel.

D. FUEL PRESSURE INDICATOR. The [fuel pressure indicator](#) displays the PSI pressure of the fuel being delivered by the boost pumps from the fuel cells to the engine. The circuit receives power from the 28 VAC bus and is protected by the FUEL PRESSURE circuit breaker in the AC circuit breaker panel.

E. FUEL QUANTITY LOW CAUTION LIGHT. The [20 MINUTE FUEL caution light](#) will illuminate when there is approximately 185 (130 to 240) pounds remaining. The illumination of this light does not mean a fixed time period remains before fuel exhaustion, but is an indication that a low fuel condition exists. Electrical power is supplied from the 28 VDC essential bus. The CAUTION LIGHTS circuit breaker protects the circuit.

F. FUEL BOOST PUMP CAUTION LIGHTS. The [LEFT FUEL BOOST and RIGHT FUEL BOOST caution lights](#) will illuminate when the left/right fuel boost pumps fail to pump fuel. The circuits receive power from the 28 VDC essential bus. Circuit protection is provided by the CAUTION LIGHTS, RH FUEL BOOST PUMP and LH FUEL BOOST PUMP circuit breakers.

6.2. Electrical system

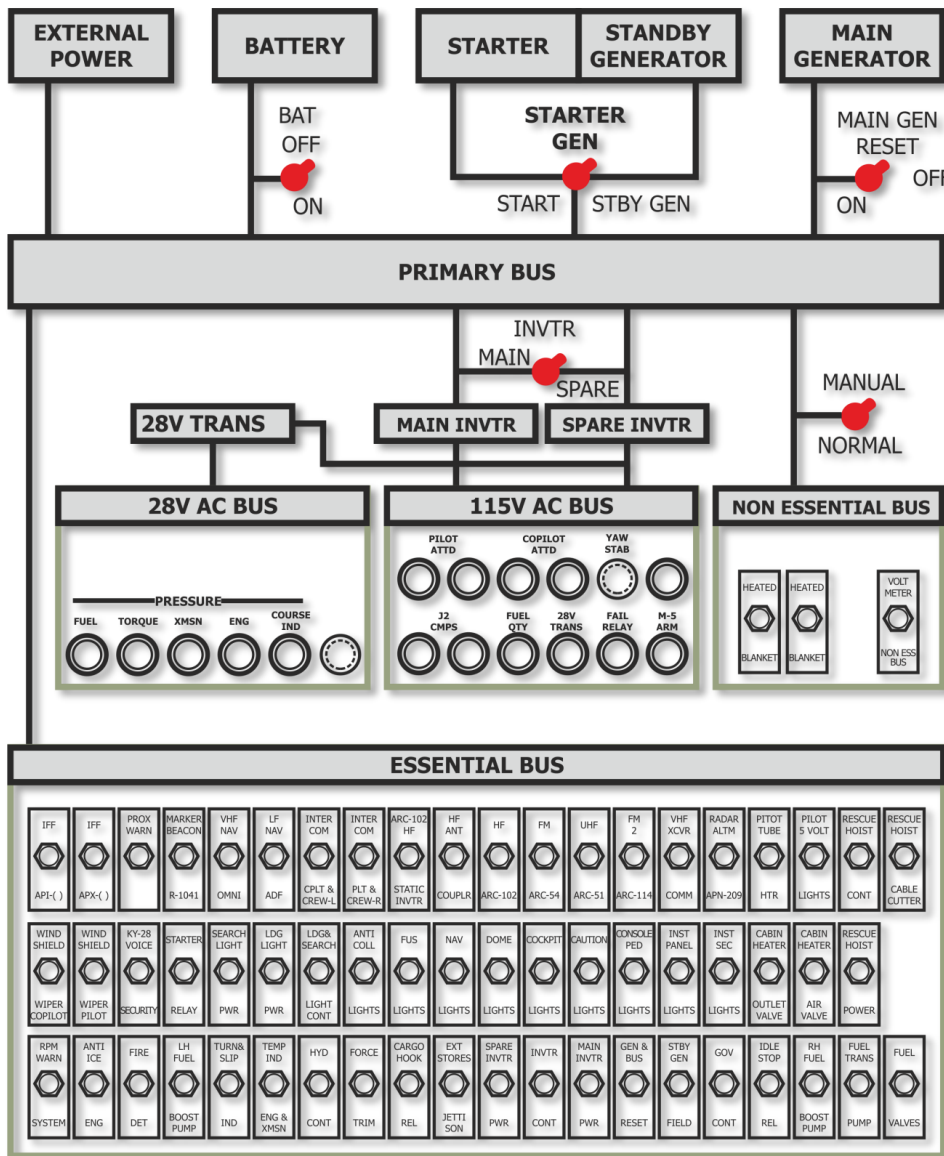

Figure 6.2. Electrical System Schematic.

6.2.1. DC and AC Power Distribution

[Figure 6.2.](#) Figure 6.4 depicts the general schematic of the DC and AC power distribution system. The DC power is supplied by the battery, main generator, standby starter-generator, or the external power receptacle. The 115 VAC power is supplied by the main or spare inverters. The 28 VAC power is supplied by a transformer which is powered by the inverter.

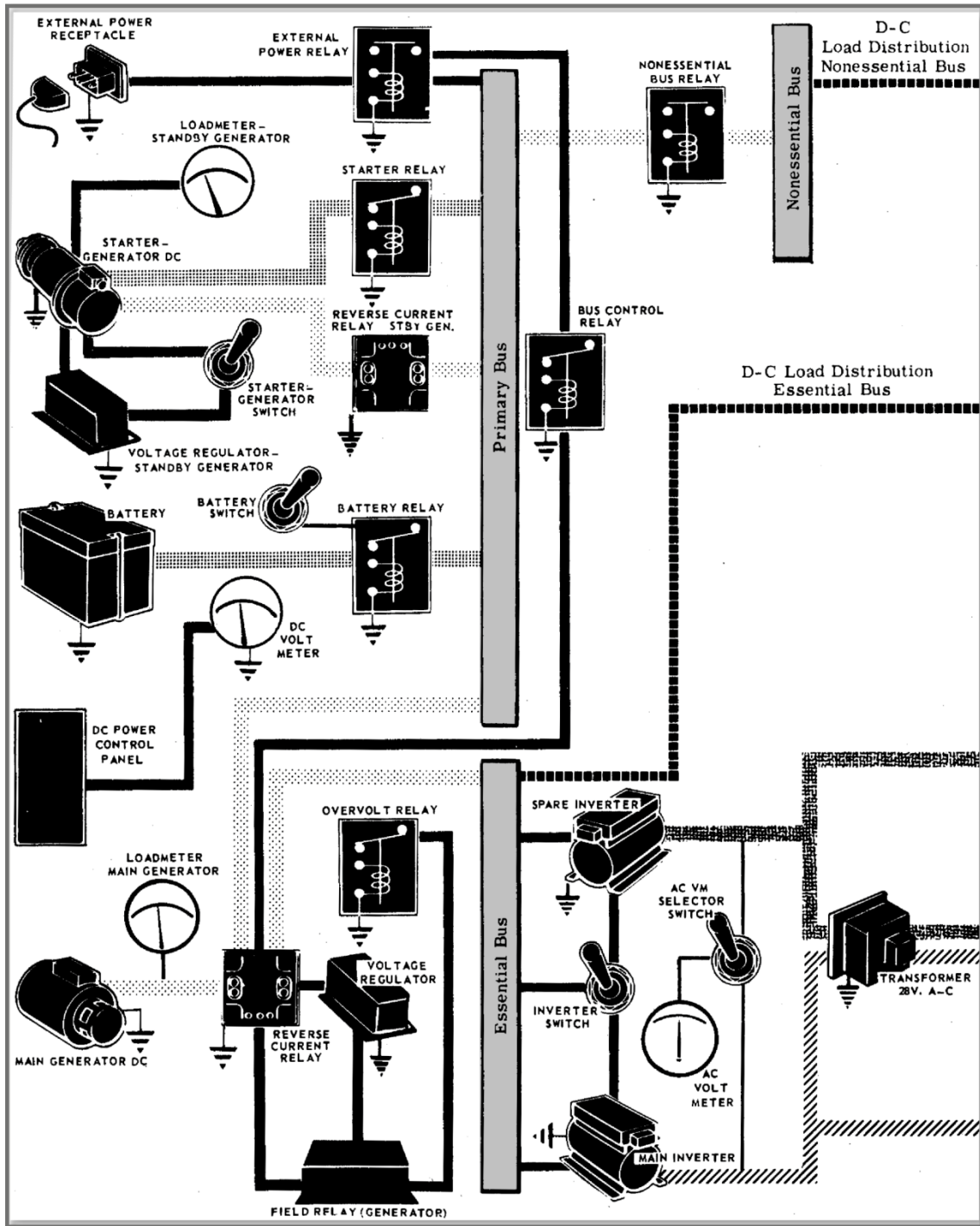

Figure 6.3. Electrical Schematic Diagram.

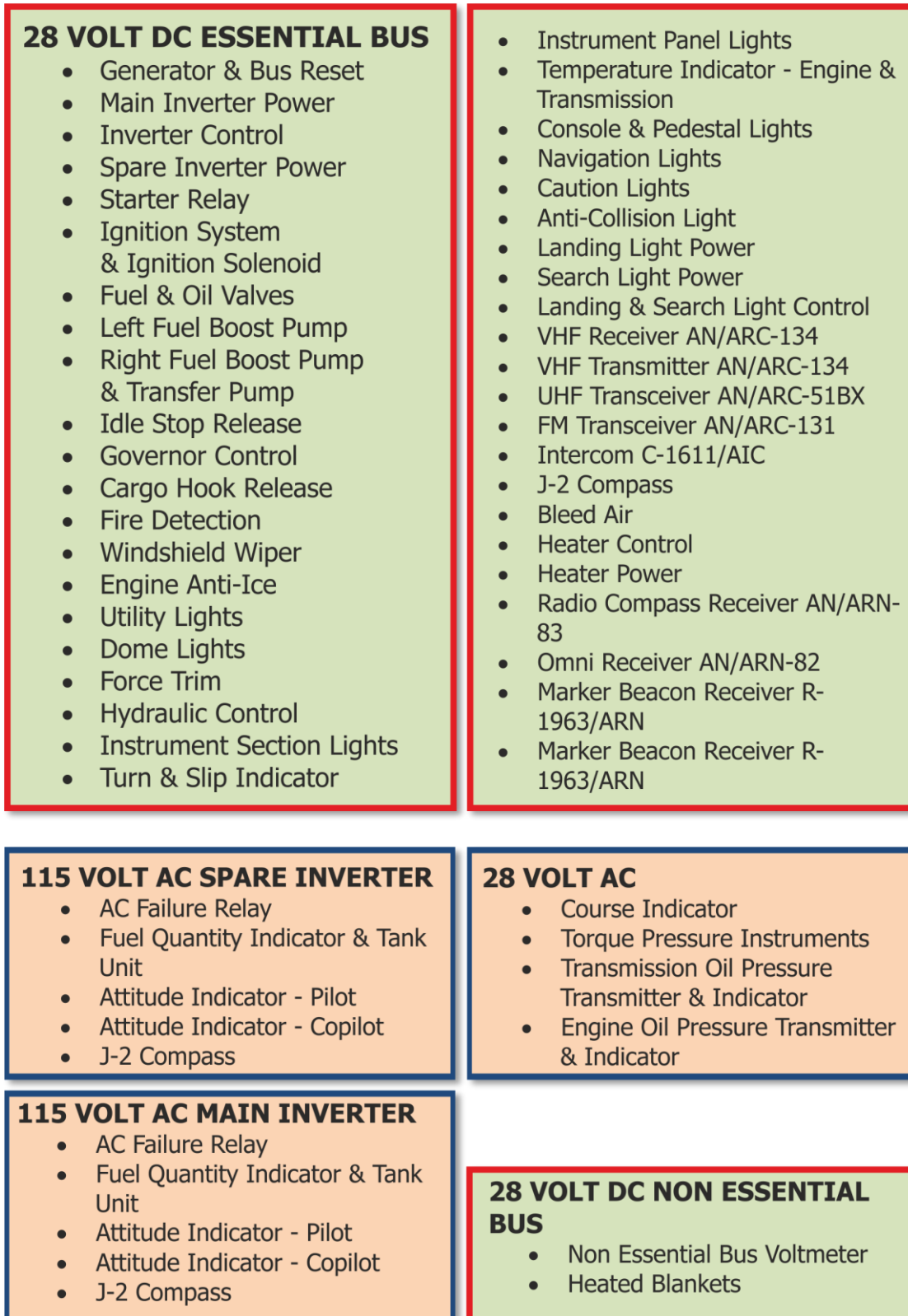

Figure 6.4. DC and AC Power Distribution Diagram.

6.2.2. DC Power Supply System

The DC power supply system is a single conductor system with the negative leads of the generator grounded in the helicopter fuselage structure. The main generator voltage will vary from 27 to 28.5 depending on the average ambient

temperature. In the event of a generator failure the nonessential bus is automatically de-energized. The pilot may override the automatic action by positioning the NON-ESS BUS switch on the DC POWER control panel to MANUAL ON.

6.2.3. DC Power Indicators and Controls

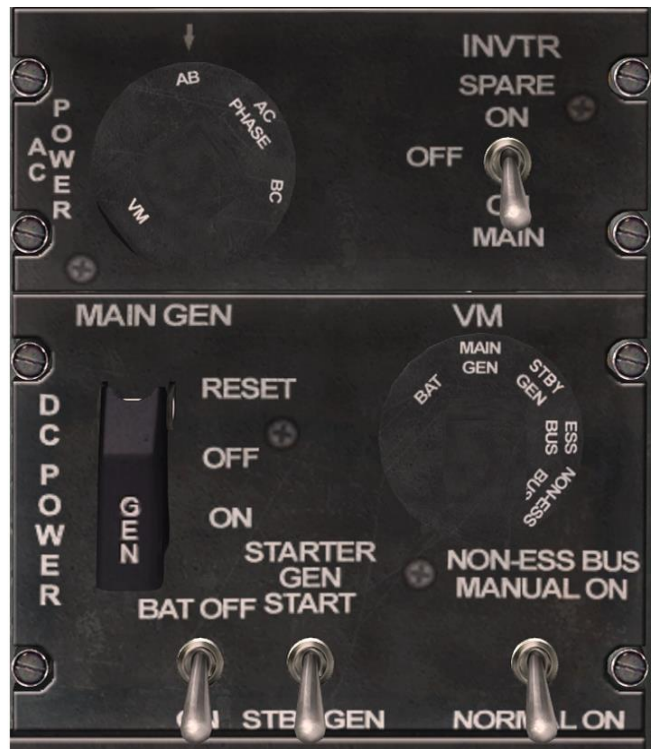

Figure 6.5. Overhead Console AC and DC POWER Panel.

A. MAIN GENERATOR SWITCH The MAIN GEN switch ([Figure 6.5](#)) is on the overhead console DC POWER panel. In the ON position the main generator supplies power to the distribution system. The RESET position is springloaded to the OFF position. Momentarily holding the switch to RESET position will reset the main generator. The OFF position isolates the generator from the system. The circuit is protected by the GEN & BUS RESET in the DC circuit breaker panel.

B. BATTERY SWITCH The BAT switch is located on the DC POWER control panel. ON position permits the battery to supply power and also to be charged by the generator. The OFF position isolates the battery from the system.

C. STARTER-GENERATOR SWITCH The STARTER GEN switch is located on the DC POWER control panel. The START position permits the starter-generator to function as a starter. The STBY GEN position permits the starter-generator to function as a generator.

D. NONESSENTIAL BUS SWITCH. The NON-ESS BUS switch is located on the DC POWER control panel. The NORMAL ON position permits the nonessential bus to receive DC power from the main generator. MANUAL ON position permits the nonessential bus to receive power from the standby generator when the main generator is off line.

E. DC VOLTMETER SELECTOR SWITCH The VM switch is located on the DC POWER control panel. The switch permits monitoring of voltage being delivered from any of the following; BAT, MAIN GEN, STBY GEN, ESS BUS, and NON-ESS BUS.

F. DC VOLTMETER. The DC voltmeter is located in the center area of the instrument panel and is labeled VOLT DC. Direct current voltage is indicated on the voltmeter as selected by the VM switch in the overhead console.

G. DC LOADMETERS-MAIN AND STANDBY. Two direct current loadmeters are mounted in the lower center area of the instrument panel. The MAIN GEN loadmeter indicates the percentage of main generator rated capacity being used. The STBY GEN loadmeter indicates the percentage of standby generator rated capacity being used. The loadmeters will not indicate percentage when the generators are not operating.

H. DC CIRCUIT BREAKER PANEL. The DC circuit breaker panel is located in the overhead console. In the "pushed in" position the circuit breakers provide circuit protection for DC equipment. In the "pulled out" position the circuit breakers deenergize the circuit. In the event of an overload the circuit breaker protecting that circuit will "pop out". Each breaker is labeled for the particular circuit it protects. Each applicable breaker is listed in the paragraph describing the equipment it protects.

6.2.4. AC Power Supply System

Alternating current is supplied by two inverters ([Figure 6.2](#)). They receive power from the essential bus and are controlled from the AC POWER control panel ([Figure 6.5](#)).

INVERTERS. Either the main or spare inverter (at the pilots option) will supply the necessary 115 VAC to the distribution system. The inverters also supply 115 VAC to the 28 Volt AC transformer which in turn supplies 28 VAC to the necessary equipment. Circuit protection for the inverters is provided by the MAIN INVTR PWR and SPARE INVTR PWR circuit breakers.

6.2.5. AC Power Indicators and Controls

A. INVERTER SWITCH. The INVTR switch is located on the AC POWER control panel in the overhead console. The switch is normally in the MAIN ON position, to energize the main inverter. In the event of a main inverter failure, the switch can be positioned to SPARE ON to energize the spare inverter. Electrical power to the INVTR switch is supplied from the essential bus. Circuit protection is provided by the INVTR CONT circuit breaker.

B. AC FAILURE CAUTION LIGHT. The [INST INVERTER caution light](#) will illuminate when the inverter in use fails or when the INVTR switch is in the OFF position.

C. AC VOLTMETER SELECTOR SWITCH. The AC PHASE VM switch is located on the AC POWER control panel. The switch is used to select any one of the three phases of the 115 VAC three-phase current for monitoring on the AC voltmeter. The three positions on the switch are: AB, AC, and BC. Each position indicates that respective phase of the 115 VAC on the AC voltmeter.

D. AC VOLTMETER. The AC voltmeter is mounted on the center area of the instrument panel (Figure 5.1). The AC voltage output from the inverter (main or spare) is indicated on this instrument. The voltage indicated on any of the three selected positions should be 112 to 118 VAC.

E. AC CIRCUIT BREAKER PANEL. The AC circuit breaker panel is located on the right side of the pedestal panel. The circuit breakers in the "pushed in" position provide circuit protection for the equipment. The breakers in the "pulled out" position de-energize the circuit. The breakers will pop out automatically in the event of a circuit overload. Each breaker is labeled for the particular circuit it protects. Each applicable breaker is listed in the paragraph describing the equipment it protects.

6.3. Hydraulic system

DESCRIPTION. The hydraulic system is used to minimize the force required by the pilot to move the cyclic, collective and pedal controls. A hydraulic pump, mounted on and driven by the transmission supplies pressure to the hydraulic servos. The hydraulic servos are connected into the mechanical linkage of the helicopter flight control system. Movement of the controls in any direction causes a valve, in the appropriate system, to open and admit hydraulic pressure which actuates the cylinder, thereby reducing the force-load required for control movement. Irreversible valves are installed on the cyclic and collective hydraulic servo cylinders to prevent main rotor feedback to the cyclic and collective in the event of hydraulic system malfunction.

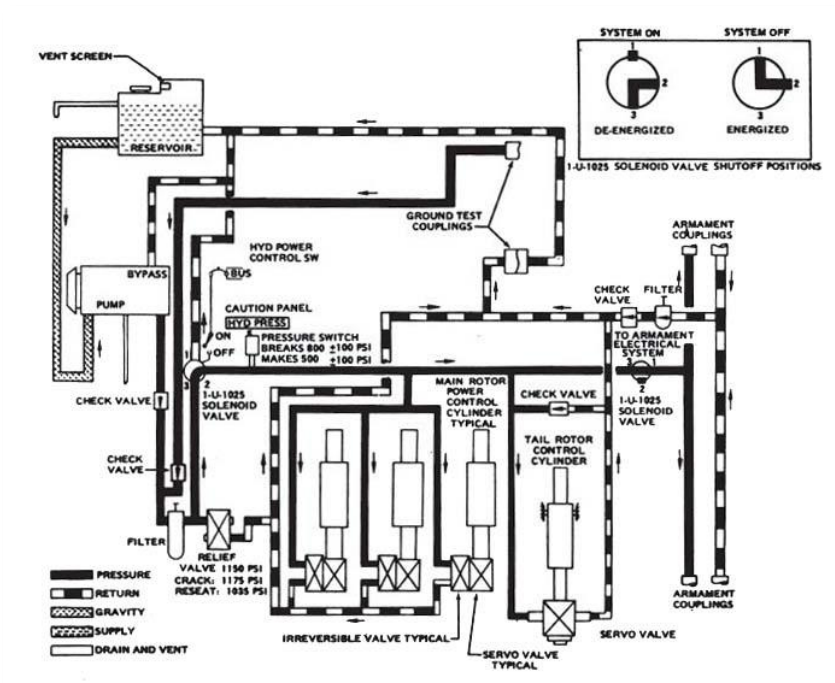

Figure 6.6. Hydraulic System Schematic.

CONTROL SWITCH. The hydraulic control switch is located on the miscellaneous panel. The switch is a two-position toggle type labeled HYD CONTROL ON/OFF. When the switch is in the ON position, pressure is supplied to the servo system. When the switch is in the OFF position, the solenoid valve is closed and no

pressure is supplied to the system. The switch is a fail-safe type. Electrical power is required to turn the switch off.

HYDRAULIC PRESSURE CAUTION LIGHT. [Low hydraulic system pressure](#) will be indicated by the illumination of HYD PRESSURE segment on the caution panel. Moderate feedback forces will be noticed in the controls when moved.

Electrical power for hydraulic system control is supplied by the 28 VDC essential bus. The circuit is protected by the HYD CONT circuit breaker.

6.4. DE-ICE

Engine de-ice is a bleed air system activated by the DE-ICE switch on the [ENGINE control panel](#). In the ON position bleed air is directed through the engine inlet to provide the protection. Power losses caused when the system is on (auto increase rpm gas producer at 3..5%). In the event of DC electrical failure or when the DE-ICE ENG circuit breaker is out, de-ice is automatically ON. System power is provided by the DC essential bus and protected by the ANTI-ICE ENG circuit breaker.

6.5. Game autopilot

Note. To simplify the use of helicopter-carried weapons when occupying other crew members' positions (copilot, door gunners), helicopter is under control of a virtual pilot. This mode is implemented as an autopilot. The game autopilot has three operation modes: ATTITUDE HOLD, LEVEL FLIGHT, ORBIT.

ATTITUDE HOLD – autopilot maintains all flight parameters that have been established right before turning on the autopilot (roll, pitch, direction, without stabilization of altitude and speed);

LEVEL FLIGHT – autopilot maintains speed, direction and altitude. If on autopilot start time there was non-zero bank angle, it gets reduced to zero;

ORBIT – autopilot maintains constant turns with a roll of 13° at a constant speed without descending. If on autopilot start time there was a greater bank angle – it gets reduced down to 13°. If existing speed does not allow for such turn without descend, then speed gets lowered to the maximum speed at which the helicopter flies without descending.

DCS: UH-1H includes a special weapon systems and autopilot status indicator on the right side of the screen to help quickly assess the status of your weapon systems and autopilot modes, as well as get quick hints of the keyboard commands required to operate them. The display can be turned on and off by pressing [\[LCTRL+LSHIFT+H\]](#). See [Figure 6.7](#), [Figure 6.8](#).



Figure 6.7. Location of Autopilot and Weapon Status Indicators on Screen.

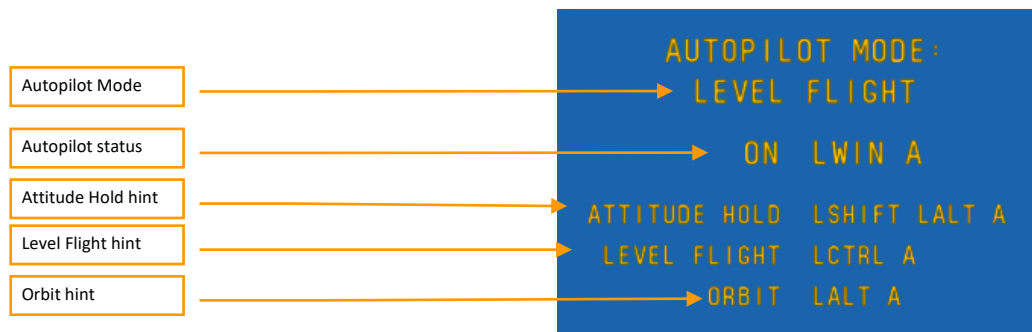

Figure 6.8. Autopilot Status Indicator.

- **AUTOPILOT MODE.** Displays the currently selected autopilot mode (ATTITUDE HOLD/LEVEL FLIGHT/ORBIT).
- **AUTOPILOT STATUS.** Displays the status of the autopilot (ON/OFF) and the default keyboard command used to change it.
- **ATTITUDE HOLD** hint. Displays the default keyboard commands used to selected ATTITUDE HOLD autopilot mode.
- **LEVEL FLIGHT** hint. Displays the default keyboard commands used to selected LEVEL FLIGHT autopilot mode.
- **ORBIT** hint. Displays the default keyboard commands used to selected ORBIT autopilot mode.

When autopilot is ON, a white mark indicates the position of the autopilot's control stick (virtual second pilot), see Figure 6.9.

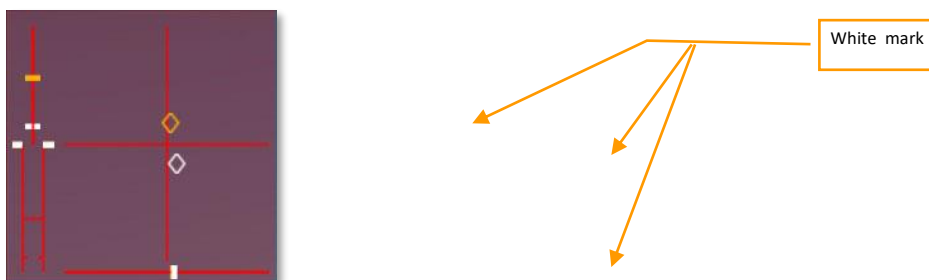

Figure 6.9 Indication of Autopilot's Control Stick Position.



7

RADIO COMMUNICATIONS

7. RADIO COMMUNICATIONS AND NAVIGATION EQUIPMENT

7.1. Radio communications equipment

The radio communications equipment of the UH-1H includes:

- C-1611/AIC Signal Distribution Panel
- AN/ARC-51BX UHF Radio Set
- AN/ARC-134 VHF Radio Set
- AN/ARC-131 FM Radio Set
- AN/APX-72 Transponder Set

7.1.1. C-1611/AIC Signal Distribution Panel

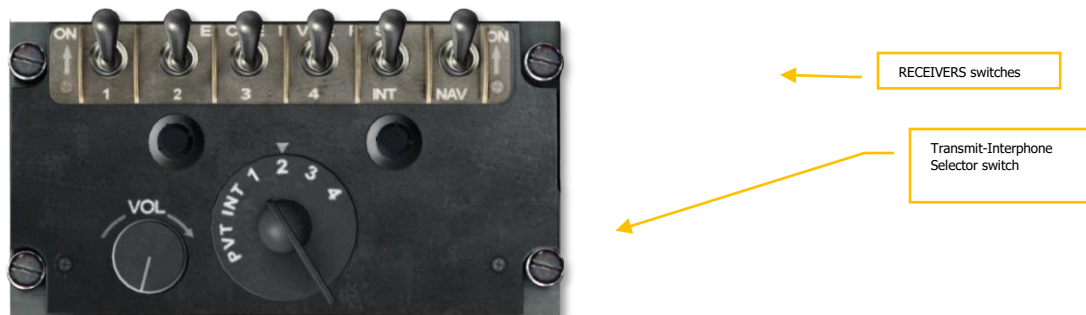

Figure 7.1. C-1611/AIC Signal Distribution Panel.

A. Description

The Signal Distribution Panel amplifies and controls the distribution of audio signals applied to or from each headset-microphone, to or from communication receivers and transmitters, from navigation receivers, intercommunication between crewmembers, and for monitoring the communication and navigation receivers singly or in combination. In addition the C-1611/AIC panel permits the operator to control four receiver-transmitters. A private interphone line is also provided.

When the selector switch is in the PVT (private) position, it provides a hot line (no external switch is used) to any station in the helicopter which also has PVT selected. A HOT MIC switch is also provided on the C-1611/AIC control panel at the medical attendant's station to permit hand-free intercommunications with Transmit-Interphone Selector in any position. Up to four C-1611/AIC units may be installed. One each of the units are installed for the pilot and copilot, and two are installed in the crew/passenger compartment of the crew. All four of the C-1611/AIC units are wired to provide interphone operations for the crew, and full transmit and receive facilities for all communication and navigation equipment.

B. Operation

- (1) Transmit interphone selector switch – as desired.
- (2) RECEIVERS switches – as desired.
- (3) Microphone switches – as desired.
- (4) VOL control – Adjust.

CONTROL	FUNCTION
RECEIVERS switches: 1 (FM) – AN/ARC-131 FM radio set 2 (UHF) – AN/ARC-51BX UHF radio set 3 (VHF) – AN/ARC-134 VHF radio set 4 (#2 FM/HF)	Turns audio from associated receiver ON or OFF. <i>IN GAME POSITION "2" IS DEFAULT</i>
INT switch	ON position enables operator to hear audio from the interphone.
NAV switch	ON position enables operator to monitor audio from the navigation receiver.
VOL control	Adjusts audio on receivers except NAV receivers.
Transmit-interphone selector switch	Positions 1 (FM), 2 (UHF), 3 (VHF), 4 (#2 FM/HF) and INT permits INT or selected receiver-transmitter to transmit and receive. The cyclic stick switch or foot switch must be used to transmit. PVT position keys interphone for transmission.

7.1.2. AN/ARC-51BX UHF Radio Set

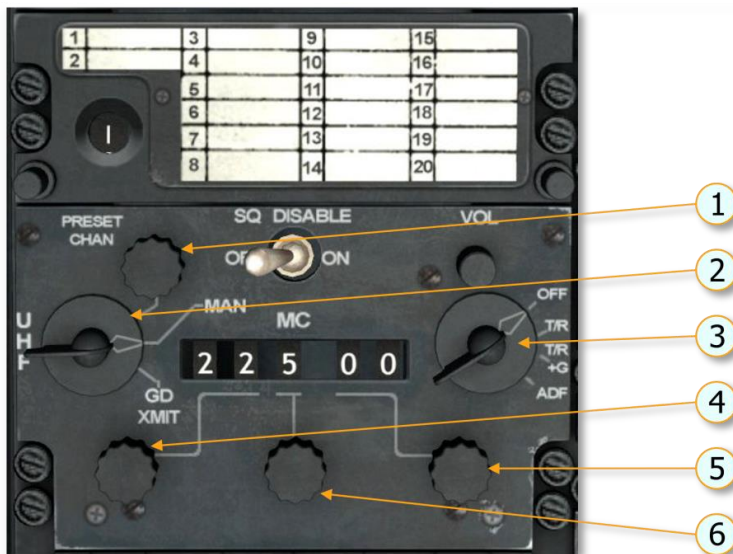

Figure 7.2. UHF Control Panel C-6287/ARC-51BX.

1. Preset channel control
2. Mode selector
3. Function select switch
4. 10 Megahertz control
5. 0.05 Megahertz control
6. 1 Megahertz control

A. Description

The Radio Set provides two way communications in the UHF (225.0 to 399.9 MHz) band. The set located at the left side of the pedestal, tunes in 0.05 MHz increments and provides 3500 channels. The set also permits 20 preset channels and monitoring of the guard channel. Transmission and reception are conducted on the same frequency.

B. Operation

- (1) UHF function select switch – T/R (T/R+G as desired).
- (2) UHF mode selector switch – PRESET CHAN.
- (3) RECEIVERS switch No. 2 – ON.
- (4) Channel – Select.

NOTE. An 800-cps audio tone should be heard during channel changing cycle.

- (5) SQ DISABLE switch – OFF.
- (6) VOL – Adjust.
- (7) Transmit-interphone selector switch – No. 2 position.

C. Emergency Operation

- (1) UHF mode switch – GD XMIT.
- (2) UHF function switch – T/R+G.

CONTROL/INDICATOR	FUNCTION
Function select switch	Applies power to radio set and selects type of operation as follows: OFF position - Removes operating power from the set. T/R position - Transmitter and main receiver ON. T/R + G position - Transmitter, main receiver and guard receiver ON. ADF position – Energizes the UHF-DF system when installed.
VOL control	Controls the receiver audio volume.
SQ DISABLE switch	In the ON position, squelch is disabled. In the OFF position, the squelch is operative.
Mode Selector	Determines the manner in which the frequencies are selected as follows: PRESET CHAN position – Permits selection of one of 20 preset channels by means of preset channel control. MAN position – Permits frequency selection by means of megacycle controls. GD XMIT position – Receiver-transmitter automatically tunes to guard channel frequency (243.00 MHz).
Preset channel control	Permits selection of any one of 20 preset channels.
Preset channel indicator	Indicates the preset channel selected by the preset channel control.
Ten Megahertz control	Sets the first two digits (or ten-megahertz number).
One Megahertz control	Sets the third digit (or one-megahertz number).
Five-hundredths Megahertz control	Sets the fourth and fifth digits (or 0.05 megahertz number).

7.1.3. AN/ARC-134 VHF Radio Set



Figure 7.3. VHF Control Panel C-7197/ARC-134.

1. Frequency indicator
2. Communication test switch
3. Off/power switch
4. Volume control
5. Kilohertz selector
6. Megahertz selector

A. Description

The AN/ARC-134 VHF radio set transmits and receives on the same frequency. The panel (labeled VHF COMM) is located on the left side of the pedestal. The set provides voice communications in the VHF range of 116.000 through 149.975 MHz on 1360 channels spaced 25 kHz apart.

B. Operation

- (1) OFF/PWR switch – PWR. Allow set to warm up.
- (2) Frequency – set as desired.
- (3) RECEIVERS switch No. 3 – ON.
- (4) Volume – adjust as desired. If signal is not audible with VOL control fully clockwise, press COMM TEST switch to unsquelch circuits.
- (5) Transmit-interphone selector switch – No. 3 position.
- (6) OFF/PWR switch – OFF.

C. Emergency Operation

Select guard frequency (121.500 MHz).

CONTROL/INDICATOR	FUNCTION
OFF/PWR switch	Turns power to the set ON or OFF.
VOL control	Controls the receiver audio volume.
COMM-TEST switch	Turns squelch on or off.
Megahertz control	Selects the whole number part of the operating frequency.
Kilohertz control	Selects the decimal number part of the operating frequency.

7.1.4. AN/ARC-131 FM Radio Set

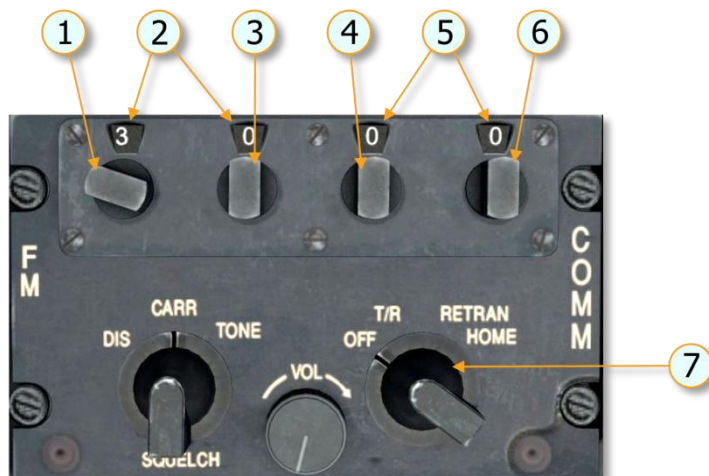

Figure 7.4. FM Radio Set Control Panel AN/ARC-131.

1. Tens megahertz digit frequency selector
2. Frequency indicators
3. Units megahertz digit frequency selector
4. Tenths megahertz digit frequency selector
5. Frequency indicators
6. Hundredths megahertz digit frequency selector
7. Mode control switch

A. Description

The FM radio set consists of a receiver-transmitter, remote control panel unit, communication antenna and a homing antenna. The radio set provides 920 channels spaced 50 kHz apart within a frequency range of 30.00 to 75.95 MHz. Circuits are included to provide transmission sidetone monitoring. The control panel is located on the pedestal. Homing data is displayed by the course indicator on the instrument panel. A channel changing tone should be heard in the headset while the radio set is tuning. When the tone stops, the radio set is tuned. Operation in DIS position is possible; however flags on the course deviation indicator will be inoperative. When the first FM radio set is in the homing mode, the homing indicator may deflect left or right of on course indication while the second FM radio set is keyed.

B. Operation

Depending on the settings of the control panel controls, the radio set can be used for the following types of operation: two-way voice communication and homing.

TWO WAY VOICE COMMUNICATION.

- (1) Mode control switch – T/R (allow two minute warm up).
- (2) Frequency – Select.

- (3) RECEIVERS No. 1 switch – ON.
- (4) VOL control – Adjust.
- (5) SQUELCH control – Set for desired squelch mode.
- (6) TRANS selector switch – No. 1.

HOMING OPERATION.

- (1) Mode control switch – HOME.
- (2) Frequency – Adjust to frequency of selected homing station.
- (3) SQUELCH control may be set to CARR or TONE, however, the carrier squelch is automatically selected by an internal contact arrangement on HOME position.
- (4) Fly helicopter toward the homing station by heading in direction that causes homing course deviation indicator right-left vertical pointer to position itself in the center of the indicator scale. To ensure that the helicopter is not heading away from the homing station, change the heading slightly and note that the course deviation indicator vertical pointer deflects in direction opposite that of the turn.

C. Retransmit Operation

Start the equipment and proceed as follows for retransmit operation:

- (1) Mode controls (both control units) – RETRAN.
- (2) SQUELCH controls (both control units) – Set as required. Do not attempt retransmit operation with SQUELCH controls set to DIS. Both controls must be set to CARR or TONE. To operate satisfactorily, the two radio sets must be tuned to frequencies at least 3 MHz apart.
- (3) Frequency adjust (both control units) for the desired operation.

D. Stopping Procedure

Mode control switch – OFF.

CONTROL/INDICATOR	FUNCTION
Mode control switch (four-position switch)	
OFF	Turns off primary power.
T/R (transmit/receive)	Radio set operates in normal communication mode (reception). (Aircraft transmit switch must be depressed to transmit.)
RETRAN (retransmit)	Radio set operates as a two-way relay station. (Two radio sets are required set at least 3 MHz apart.)
HOME	Radio set operates as a homing facility. (Requires a homing antenna and indicator.)
VOL control	Adjusts the audio output level of the radio set.
SQUELCH switch (three-position rotary switch)	

DIS (disable)	Squelch circuits are disabled.
CARR (carrier)	Squelch circuits operate normally in presence of any carrier.
TONE	Squelch opens (unsquelches) only on selected signals (signals containing a 150-cps tone modulation).
Frequency indicator	
Tens megahertz frequency selector	Selects the tens megahertz digit of the operating frequency.
Units megahertz frequency selector	Selects the units megahertz digit of the operating frequency.
Tenths megahertz frequency selector	Selects the tenths megahertz digit of the operating frequency.
Hundredths megahertz frequency selector	Selects the hundredths megahertz digit of the operating frequency.
Frequency indicator	Displays the operating frequency of the radio set.

7.1.5. AN/APX-72 Transponder Set (equipment is installed, but functions are not implemented in DCS: UH-1H)

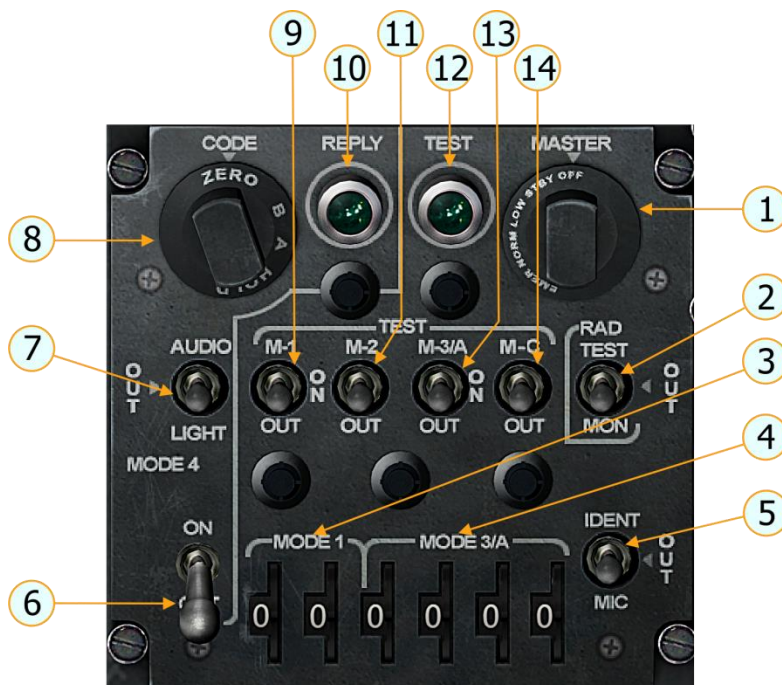

Figure 7.5. AN/APX-72 Transponder Set.

The AN/APX-72 provides radar identification capability. This system is not modeled in DCS: UH-1H.

7.2. Radio Navigation Equipment

The radio navigation equipment of the UH-1H includes:

- AN/ARN-82 VHF Navigation Set
- [AN/ARN-83 ADF Set](#)
- ID-998/ASN Radio Magnetic Indicator (RMI)
- ID-1347/ARN-82 Course Deviation Indicator (CDI)

7.2.1. AN/ARN-82 VHF Navigation Set



Figure 7.6. Navigation Control Panel AN/ARN-82.

A. Description

The Navigation Receiver set provides reception on 200 channels, with 50 kHz spacing between 108.0 and 126.95 MHz. This permits reception of the VHF omnidirectional range (VOR) between 108.0 and 117.95 MHz. The Vocalizers are received on odd-tenth MHz, between 108.0 and 112.0 MHz and energized as selected. Both VOR and localizer are received aurally through the interphone system. The VOR is presented visually by the course indicator and the number 2 pointer on the bearing indicator and the localizer is presented visually by the vertical needle on the CDI. When the R-1963/ARN Glideslope/Marker Beacon Receiver is installed, the glideslope frequency is selected by tuning an associated localizer frequency on the control panel.

B. Operation

- (1) Function switch – PWR.
- (2) RECEIVERS NAV switch – ON.
- (3) Frequency – Select.
- (4) VOL – Adjust.

CONTROL/INDICAT OR	FUNCTION
VOL control	Controls receiver audio volume.
Power switch	Turns primary power to the radio set and to the R-1963/ARN Marker Beacon/Glideslope Receiver ON or OFF. Allows for accuracy of Course Deviation Indicators and Marker Beacon Indicator lamp in the TEST position.
Whole megahertz channel selector knob	This is the control knob on the left side. It is used to select the whole megahertz number of the desired frequency.
Fractional megahertz channel selector knob	This is the control knob on the right side. It is used to select the fractional megahertz number of the desired frequency.

7.2.2. AN/ARN-83 ADF Set

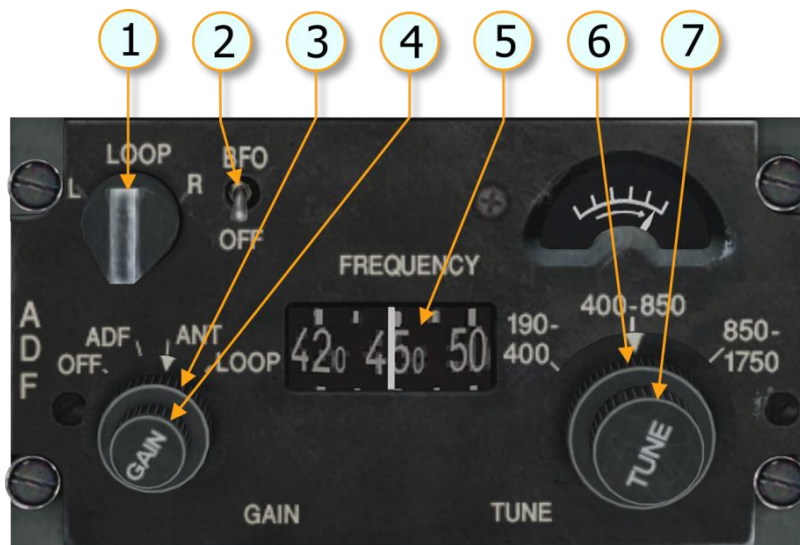

Figure 7.7. Direction Finder Control Panel ARN-83.

1. Loop L/R switch
2. [BFO](#) switch
3. Mode selector switch
4. GAIN control
5. Frequency dial
6. Band selector switch
7. TUNE control Tuning meter

A. Description

The Automatic Direction Finder set provides radio aid to navigation within the 190 to 1750 kHz frequency range. In automatic operation, the set presents continuous bearing information to any selected radio station and simultaneously provides aural reception of the station's transmission. In manual operation, the operator determines the bearing to any selected radio station by controlling the aural null of the directional antenna. The set may also be operated as a receiver.

B. Operation

- a) Automatic Operation.
 - (1) RECEIVERS NAV switch – ON.
 - (2) Mode selector switch – ADF.
 - (3) Frequency – Select.
 - (4) Volume – Adjust.
- b) Manual Operation.
 - (1) Mode selector switch – LOOP.
 - (2) BFO switch – ON.

(3) LOOP L/R switch – Press right or left and rotate loop for null.

CONTROL/INDICAT OR	FUNCTION
Band selector switch	Selects the desired frequency band.
TUNE control	Selects the desired frequency.
Tuning meter	Facilitates accurate tuning of the receiver.
GAIN control	Controls receiver audio volume.
Mode selector switch	Turns set OFF and selects ADF, ANT and LOOP modes of operation.
LOOP L/R switch	Controls rotation of loop left or right.
BFO switch	Turns BFO on or off.



8

ARMAMENT
AND MISSION

8. ARMAMENT AND MISSION AVIONICS

The armament systems of the DCS UH-1H include the M23, XM93, and M21 subsystems. This chapter includes the descriptions of these armament subsystems. [See also chapter 10 for COMBAT EMPLOYMENT description.](#)

8.1. M23 Armament Subsystem

8.1.1. M23 Armament Subsystem Description

The M23 armament subsystem is attached to the external stores hardpoint fittings on both sides of the helicopter ([Figure 8.1](#)). The M-60D flexible 7.62 millimeter machine guns are free pointing but limited in traverse, elevation, and depression by cam surfaces and stops on pointless and pintle post assemblies of the two mount assemblies on which the machine guns are mounted. An ejection control bag is latched to the right side of each M60D machine gun to hold the spent cases, unfired rounds and links. Cartridges travel from ammunition box and cover assemblies to M60D machine gun through flexible chute and brace assemblies (machine gun).



Figure 8.1. The Flexible 7.62 Millimeter Machine Guns M60D on the Left Board.

M-60D flexible 7.62 millimeter machine gun Data:

Characteristic	value
Effective range	1100 meters (max)
Rate of fire	550-650 rnds per min

8.1.2. M23 Armament Subsystem Firing Procedures

To use the side door M-60D machine guns of the M23 armament subsystem, first press [\[3\]](#) to take the position of the left door gunner or [\[4\]](#) to take the position of the right door gunner.

Two aiming modes are available and can be set in the OPTIONS > SPECIAL > UH-1H menu: Camera Aiming ON and Camera Aiming OFF.

With Camera Aiming ON, the gun/gunsight is latched to the view camera, allowing you to aim with the mouse. To fire the gun, press the left mouse button or [\[Space\]](#). You can toggle mouse-look and mouse-click mode by pressing [\[LAlt+C\]](#). Note that you can use the mouse wheel to zoom the view in and out, as well as adjust the 3D position of the view by holding the mouse wheel down while moving the mouse.

With Camera Aiming OFF, the mouse or the keyboard numpad control the camera, while the [\[;\]](#), [\[,\]](#), [\[.\]](#), [\[/\]](#) keys control the gun aim.

When you switch to a gunner's position, the currently selected autopilot mode will be engaged to maintain helicopter flight control. The autopilot can be turned on and off manually by pressing [\[LWIN+A\]](#).

8.2. XM93 Armament Subsystem

Somewhat different from the M23 armament subsystem in design, but similar in function, the XM93 armament subsystem is a door pintle mount for the M134 7.62mm "minigun", providing the door gunners the ability to operate the rapid-firing M134 in place of the M23's M60D machine guns. One XM93 platform can be mounted in either door. Each platform is provided with 3200 rounds of ammunition. Operation of the XM93 armament subsystem is identical to the M23 subsystem as described above in section [8.1.2.](#)



8.3. M21 Armament Subsystem Description

The M21 armament subsystem consists of two M134 6x barrel 7.62mm high rate machine guns and two 7-tube (M158) or 19-tube (M159) 2.75 inch aircraft rocket launchers.

Note: M158: 7-tube launcher; M158A1 was identical to LAU-68/A; M159: 19-tube launcher; M159A1 was identical to LAU-61/A.



Figure 8.2. Elements of M21 Subsystem Assembly on the Left Side of the UH-1H.

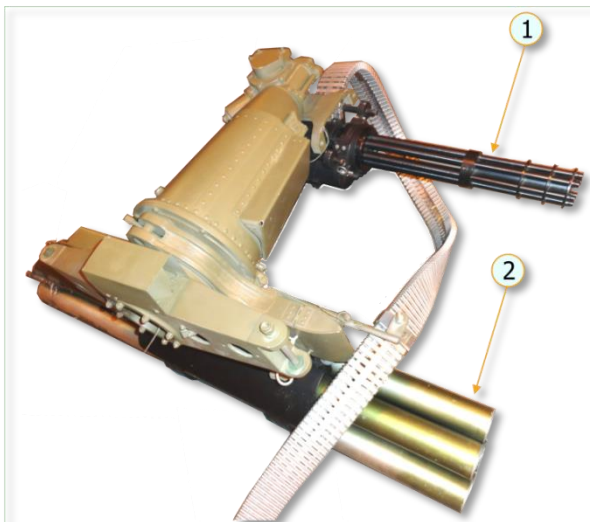

Figure 8.3. M134 (1) and M158 (2) in Assembly.

8.3.1. High rate of fire M134 7.62 automatic machine guns

- a) Flexible, using gunner's flexible sighting station.
- b) Stowed using the XM60 infinity sight and the firing on the cyclic control stick.



Figure 8.4. M134.

8.3.2. 2.75-inch folding fin aerial rockets (FFAR) M158

- a) Pair-single rocket from each launcher.
- b) Ripples of 2, 3, 4, 5, 6, or 7 pairs of rockets.

The weapon subsystem functions satisfactorily in all coordinated helicopter positions or attitudes and within helicopter speed range of 0 to 140 knots.

Rocket launchers can be jettisoned in case of in-flight emergency.

The weapon subsystem has a high degree of accuracy when both guns are boresighted or harmonized to converge at 1000 meters and the rocket launchers are boresighted to converge rocket fires at 1250 meters.

The UH-1H can employ a wide variety of 2.75 inch Hydra 70 rockets using either the XM158 seven-tube launchers or XM159 19-tube launchers. The Hydra 70 has evolved into a wide array of air-to-surface aerial rockets. All of the 2.75 inch Folding Fin Aerial Rockets (FFAR) in this simulation use the MK66 rocket motor. FFAR rockets are an area effect weapon and are certainly not a precision attack weapon. Common targets for most of the rocket warheads include un-armored or lightly armored targets and they can be useful as a suppression weapon.



Figure 8.4.1 FFAR.



Figure 8.5. 2.75 inch FFAR Warhead Types.

2.75 inch rockets that the UH-1H can use include the following warheads:

- **MK5.** High explosive anti-tank warhead.
- **MK61.** Inert warhead practice rocket.
- **M151.** Anti-personnel fragmentation warhead.
- **M156.** White phosphorus smoke warhead.
- **M274.** Training smoke marker.
- **M257.** Parachute-retarded illumination flare.

Due to limited accuracy, it is best to ripple fire explosive warhead FFARs, but generally smoke and illumination FFAR are fired as singles.

Characteristics of 2.75 inch FFAR

Average Length	1.2 m
Average Weight	8.4 kg (+ 2.7 kg for HE warhead)
Diameter	2.75 inch
Average Range	3,400 m
Rockets per pod	7
Motor	Mk 66
Motor burn range	397 m
Motor burn time	1.05 – 1.10 sec
Motor average thrust	1,330 – 1,370 lbs
Launch velocity	148 fps

8.3.3. The weapon subsystem data

Characteristic	7.62 automatic guns	2.75-inch FFAR (with M158)
Maximum effective range, m	1000	2500
Minimum safe slant range, m	100	300
Maximum range, m	3450	9300 with new motor and 10-pound warhead
Ammunition capacity	6400	14
Weight of round, lbs / g	0.053 / 24	
Rate of fire	normal – 2400 shots per minute (both) high - 4000 shots per minute. (one gun at a time)	6 pairs per second
Muzzle velocity, feet per second	2500	90
Weight, lbs / kg	1108.06 / 503	
Flexible limits Up	+10°	–
Down	-85°	–
Inboard	12°	–
Outboard	70°	–
Length of burst, sec	3	–

8.3.4. M21 armament controls

With gun mounts in the stow position, the electric drive assembly motor will only receive enough voltage to drive the gun at a rate of 2400 shots per minute. When moving the mounts through the field of deflection, one mount must stop at its inboard limit. Upon reaching the inboard limit, the gun will cease to fire and the opposite gun will accelerate to 4000 shots per minute; therefore, with both guns operational, the constant rate of fire is 4800 rounds per minute. This rate can be reduced to 2400 rounds per minute by selecting one gun (left or right) with the GUN SELECTOR switch on the control panel.



Figure 8.6. M21 Armament Control Panel.



Use the rocket PAIR SELECTOR switch for the selection of one to seven pairs of rockets.



An electrical JETTISON switch for the rocket launchers.



A rocket RESET switch to reset the rack and support assembly firing switches.

XM60 INFINITY SIGHT. The pilot uses the XM60 (Figure 8.7) infinity sight to aim the rockets and the stowed automatic guns. When the sight is not in use, it may be stowed near the helicopter's ceiling in front of the pilot. Reflex sight XM60 (reticle pattern) – Figure 8.8.

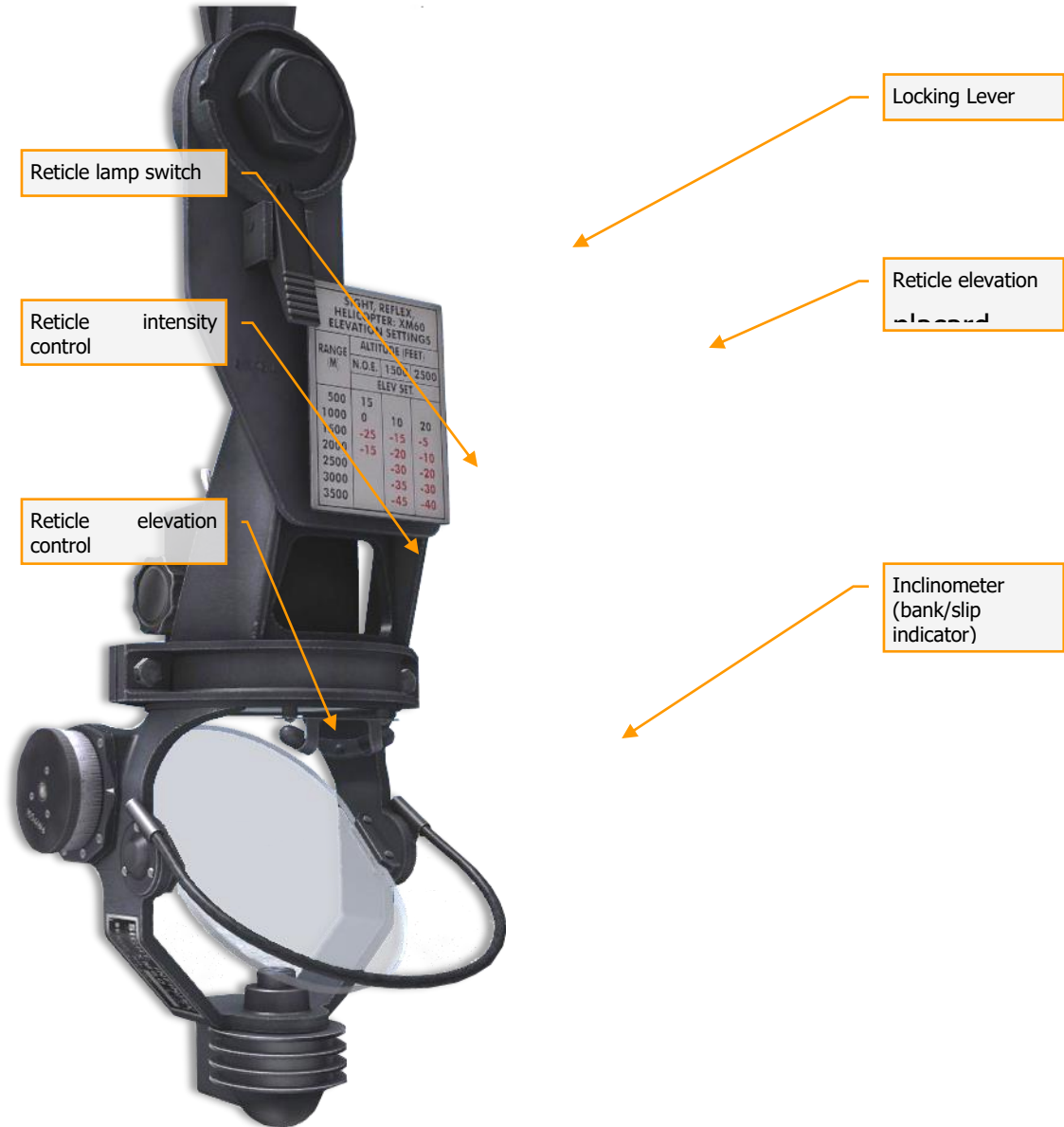

Figure 8.7. XM60 Reflex Sight.

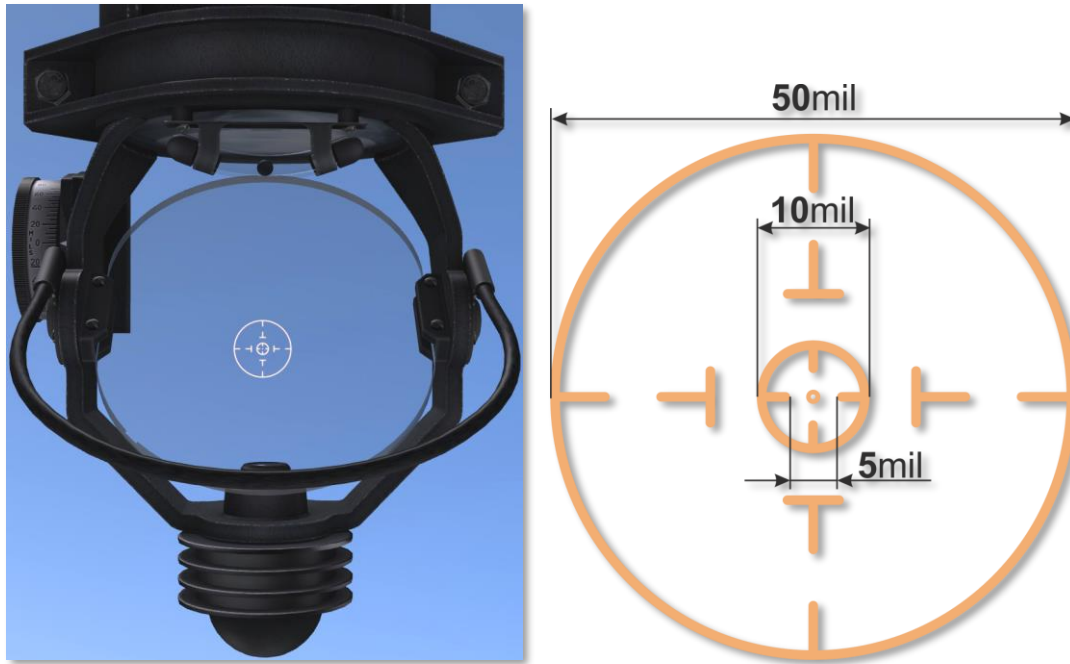

Figure 8.8. Reflex Sight XM60 – Reticle Pattern.

8.4. M21 Armament Subsystem Procedures

8.4.1. Automatic gun Firing Procedures

The gunner (copilot) can fire the 7.62mm subsystem automatic guns from the stow or flexible position, while the pilot can only fire the subsystem from the stow position.

A. STOW MODE. The guns may be stowed in a predetermined position and fired as a fixed weapon by the gunner (copilot) or the pilot. This permits straight-ahead firing in an emergency by use of the firing switch on the pilot's or gunner's cyclic stick. To fire the automatic guns in the stow position, the armament selector switch is moved to 7.62 and the OFF-SAFE-ARMED switch to ARMED.

- (1) Stow fire by the pilot. The pilot uses the XM60 infinity sight for stow fire by turning the elevation depression knob until the sight reticle pipper coincides with the strike of the bullets.
- (2) Stow fire by gunner (copilot). There is no sight for stow fire at the gunner's station; however, the gunner (copilot) may provide his own reference marks on the windshield. To verify his constant head position, he fires a few rounds and places a line on the windshield that coincides with the observed strike of the bullets. He can place a dot or a circle on the line to coincide with the center of bullet strike.

B. FLEXIBLE MODE. For flexible mode operation the gunner's procedure is to:

- (1) Disengage the sighting station from its stowed position, grasp the control handle, and pull down outboard.

- (2) Move the reticle lamp switch either forward or aft of the center off position to illuminate the reticle lamp.
- (3) Turn the rheostat knob to set reticle light intensity at desired level.
- (4) Depress the actuator bar on the control handle to transfer firing voltage from the cyclic stick firing switches to the control handle trigger switch. Then by moving the sighting station, the gun may be electrically aimed and fired.

Note. Whenever the actuator bar is released, control is returned to the stowing potentiometers and mounts are driven immediately to the stowed position. Simultaneously, electrical power is transferred from the control handle trigger to the cyclic stick firing switches.



Figure 8.9. Sighting Station – Reticle Pattern.



Figure 8.10. Sighting Station. Demo FLEXIBLE MODE (1 of 2).



Figure 8.11. Sighting Station. Demo FLEXIBLE MODE (2 of 2).

8.4.2. Rocket Firing Procedures

The 2.75-inch rocket launchers are fixed to the support assembly and can only be fired from the stow position. When the armament selector switch is positioned at 2.75, the primary subsystem mode is rocket firing by means of cyclic stick firing switches. However, automatic gun firing can still be accomplished by using the flexible sighting station. While firing rockets, the automatic gun firing will be interrupted as long as the cyclic stick firing switch is depressed. Rocket firing procedures are as follows:

A. BEFORE TAKEOFF.

1. Close the 7.62mm, rocket jettison, and XM60 sight circuit breakers.
2. Position the OFF-SAFE-ARMED switch to SAFE and check to see that the green SAFE indicator light illuminates.
3. Position the armament selector switch to 7.62. This will prevent accidental rocket firing before takeoff.
4. Check to ensure that the rocket PAIR SELECTOR switch is indicating zero pairs.
5. Depress the RESET switch to reset the firing switch on each rack and support assembly.
6. Conduct an operational check of the XM60 infinity sight as follows:
 - a) Depress the locking lever to disengage the sight from the stow indent [[LMouse click](#)] or [[RShift+M](#)] (see [Figure 8.7](#), [Figure 8.12](#)),

then swing the sight outboard and down from its stowed position until the locking lever engages the operate indentation.

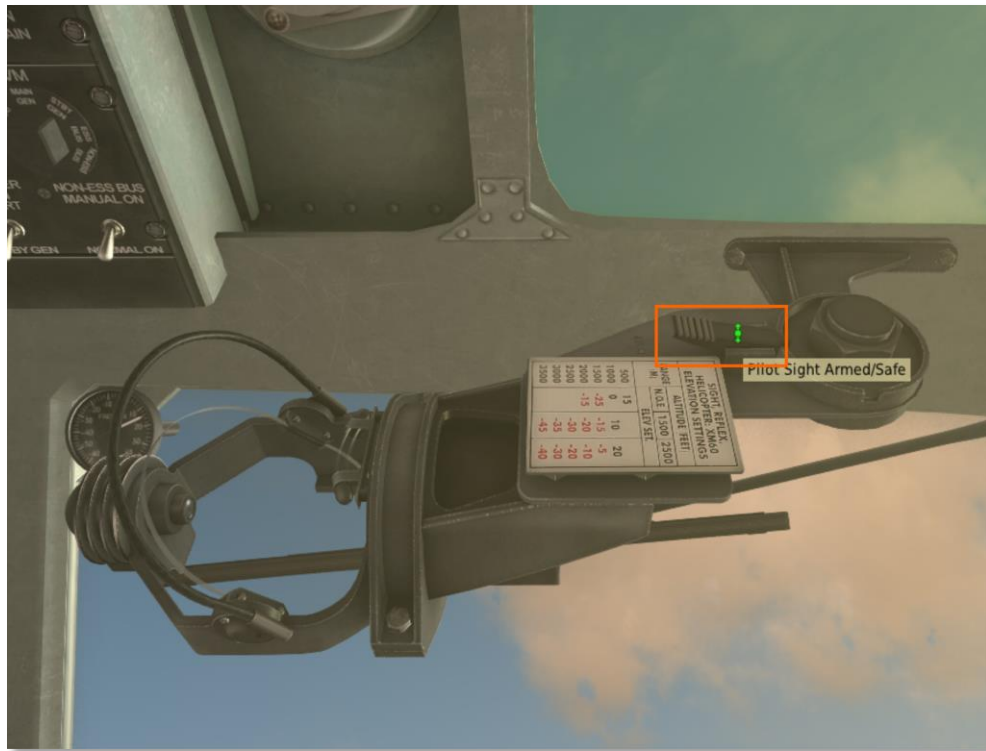

Figure 8.12. The Locking Lever of the XM60 Infinity Sight.

- b) Move the reticle lamp switch either forward or aft of the center off position to illuminate the reticle lamp [**R**Ctrl+**M**].
- c) Turn the rheostat knob to set reticle light intensity to desired level: Intensity Decrease – [**L**Alt + **X**], Intensity Increase – [**L**Ctrl + **X**] (or turn mouse wheel).
- d) Set desired Sight Elevation at the fixed index scale on the sight: Elevation Decrease – [**L**Alt + **S**], Elevation Increase – [**L**Ctrl + **S**] (or turn mouse wheel) (see Figure 8.7, [Figure 8.13](#)).



Figure 8.13. Reticle Elevation Control.***B. AFTER TAKEOFF.***

1. Prepare for firing by setting the armament selector to 2.75 and the rocket PAIR SELECTOR switch to the desired number of rocket pairs to be fired.
2. Position the OFF-SAFE-ARMED switch to ARMED and check to see that the SAFE indicator light goes out and the ARMED indicator light illuminates.
3. Using the sight reticle pipper as a reference aiming point, acquire the target by flying a target collision course, changing the attitude of the helicopter as necessary to align the sight reticle on the target.
4. When the proper sight picture has been developed, fire the rockets by depressing the firing switch on the cyclic control stick.
5. After firing position the ...
 - a) OFF-SAFE-ARMED switch to SAFE.
 - b) Armament selector to 7.62.
 - c) Rocket PAIR SELECTOR to zero pairs.
6. Before helicopter shutdown, position the OFF-SAFE-ARMED switch to OFF and then open all armament circuit breakers.

8.4.3. Rocket Emergency Procedures

Jettisoning can be safely accomplished during hovering, climbing, and level flight in the speed range from zero to 100 knots, and during autorotation and descending flight up to 80 knots. To jettison ...

- a) Lift the red switch guard to break copper safety wire on the launcher jettison switch.
- b) Push launcher jettison switch forward and check support assemblies to ensure that jettison is complete.

8.5. Flare Dispenser M130

The Flare Dispenser M130 will dispense up to 2x30 decoy flares as a countermeasure to infrared seeking missiles. The externally mounted dispenser is controlled by a DISP CONT control panel on the console and one firing switch. The system is powered by the No. 1 DC bus through the CHAFF circuit breaker on the No. 1 PDP.

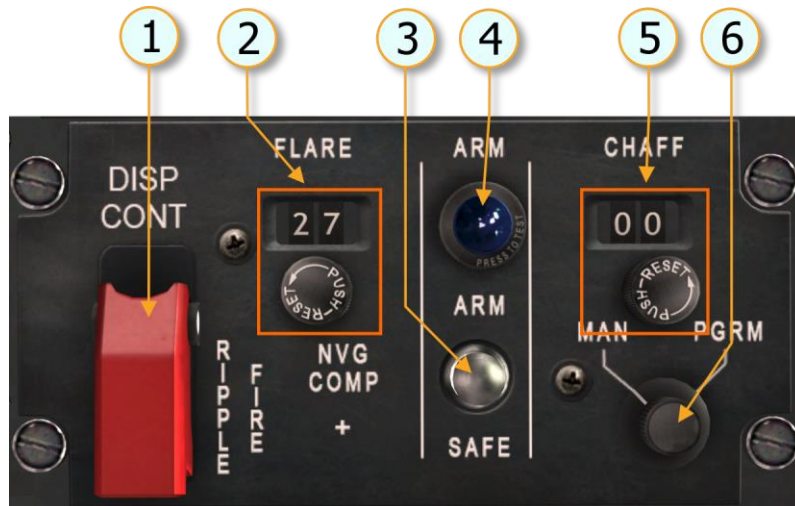

Figure 8.14. M130 Control Panel.

1. FIRE RIPPLE switch
2. FLARE counters
3. ARM/SAFE switch
4. ARM light
5. CHAFF counters
6. MAN/PRGM switch

Although the control panel, dispenser, and circuit breaker are marked CHAFF or have CHAFF (C) selector positions, chaff cannot be dispensed in this installation.

8.5.1. Dispenser Control Panel.

The DISP CONT panel is installed in the center console. The panel contains the ARM/SAFE switch, ARM indicator light, RIPPLE FIRE switch, FLARE counter, and counter setting knob. The panel also includes a MAN/PGRM switch and CHAFF counter, which are not used in this installation.

8.5.2. Controls and Function, Flare Dispenser System (M130).

- **RIPPLE FIRE** switch: While held ON, will ripple fire all remaining flare cartridges. To be used in the event of emergency.
- **ARM/SAFE** switch: At SAFE, the system is not powered. At ARM, the system is powered.
- **ARM** light: Lights when the ARM/SAFE switch is moved to the ARM position and the safety flag pin(s) has been removed from the system safety switch(es).
- **MAN/PGRM** switch: Sets manual or programmed chaff release modes. Not functional in this installation as only flares are available for dispensing.
- **FLARE - CHAFF** counters: Indicate amount of flare shots (chaff not available in this installation) remaining. Counter must be set to correspond to the number of flares carried manually prior to takeoff.

Note, the counter indicates the number of flares in a single dispenser. Two dispensers are carried and fire flares simultaneously. As such, the actual number of flares carried is twice the indicated number in the FLARE counter.

8.5.2. Flare Dispense Button.



Figure 8.3 M130 Flare Dispense Button.

The FLARE DISPENSE button is used to release flares when the M130 countermeasures system is armed. A single press of the button fires a single flare from each dispenser, of which two are equipped. Holding the button down fires a single flare from each dispenser every 3 seconds.

8.6. Gunner Artificial Intelligence (AI) control

The left pilot, left and right door gunners can be set to autonomously engage targets of opportunity. The left pilot engages targets with the M134 miniguns in Flex mode, while the door gunners engage targets using either the M134 door gun or the M60D door gun, depending on the payload profile. Turning on AI gunners requires setting the Rules of Engagement (ROE) mode for the desired gunner. In addition, the firing burst length can be set between Short and Long burst. These and other parameters can be monitored on the CREW STATUS INDICATOR.

CREW STATUS:			
HEALTH	ROE	AMMO	BURST
PILOT	PLAYER	-	-
CO-PILOT	HOLD	100%	SHORT
LH GUNNER	RET. FIRE	100%	LONG
RH GUNNER	FREE FIRE	100%	LONG

Figure 8.16. Crew Status Indicator.

- **HEALTH.** The HEALTH column indicates the alive (green) or out of action (red) state of each crew member.
- **ROE.** The ROE column indicates the current ROE setting for each gunner. The setting can be cycled between HOLD, RET. FIRE (return fire) and FREE FIRE. To cycle the ROE setting, press [LCtrl + 2], [LCtrl+3], [LCtrl + 4] for the left pilot, left door gunner, and right door

gunner, respectively. Additionally, the ROE column indicates which position is currently taken by the player.

- **AMMO.** The AMMO column indicates the amount of rounds remaining in percent for each gunner weapon.
- **BURST.** The BURST column indicates the current burst length setting for each gunner. The setting can be cycled between SHORT and LONG by pressing [LShift + 2], [LShift + 3], [LShift + 4] for the left pilot, left door gunner, and right door gunner, respectively.

The gunners' reaction time and aiming accuracy is determined by the Gunners AI Skill slider in the player-controlled UH-1H Helicopter Group properties menu.

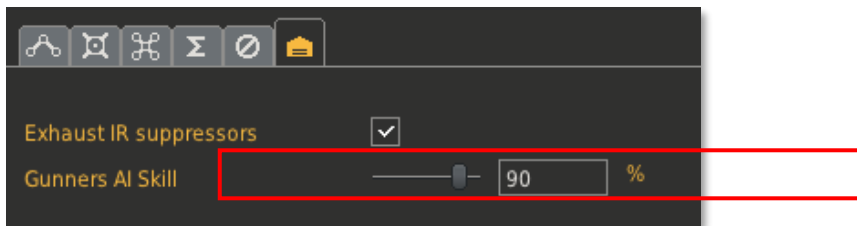

Figure 8.17. Gunners AI Skill Slider.



9

FLIGHT PREPARATION & FLIGHT

9. FLIGHT PREPARATION AND FLIGHT

9.1. Starting Engine

AUTO START ENGINE [LWIN+Home].

9.1.1. Before Starting Engine

1. Overhead switches and circuit breakers – Set as follows:
 - a) DC circuit breakers – IN, except for armament and special equipment.
 - b) DOME LT switch – As required.
 - c) AC POWER switches – Set as follows:
 - (1) PHASE switch – AC [LShift+R].
 - (2) INVTR switch – OFF [LShift+I].
 - d) DC POWER switches – Set as follows:
 - (1) MAIN GEN switch – ON and cover down [LShift+Q].
 - (2) VM selector – ESS BUS [LShift+H].
 - (3) NON-ESS BUS switch – As required.
 - (4) STARTER GEN switch – START [LShift+X].
 - (5) BAT switch – ON [LShift+P].
2. Ground power unit – Connect for GPU start.
3. FIRE warning indicator light – Test [RCtrl+T].
4. Center pedestal switches – Set as follows:
 - a) Avionics equipment – Off; set as desired.
 - b) External stores jettison handle – Check safe tied.
 - c) DISP CONTROL panel – Check ARM/STBY/SAFE switch is SAFE [RShift+RAlt+L]; check that JETTISON switch [LAlt+J] is down and covered.
 - d) GOV switch – AUTO [G].
 - e) DE-ICE switch – OFF [I].
 - f) FUEL switches – Set as follows:
 - (1) MAIN FUEL switch – ON [F].
 - (2) All other switches – OFF.
 - g) Caution panel lights – TEST [LAlt+R] and RESET [R].
 - h) HYD CONT switch – ON [LAlt+I].
 - i) FORCE TRIM switch – ON [LAlt+U].
 - j) CHIP DET switch – BOTH [LAlt+G].

5. Flight controls – Check freedom of movement through full travel: center cyclic and pedals; collective pitch full down.

6. Altimeters – Set to field elevation

FOR PILOT: pressure decrease – [RCtrl+B];

pressure increase – [RShift+B];

FOR COPILOT: pressure decrease – [LCtrl+B];

pressure increase – [LShift+B];

9.1.2. Starting Engine

1. Turn on the Controls Indicator by pressing [RCTRL + ENTER].

2. Throttle – Set for start. Position the throttle as near as possible (on decrease side) to the engine idle stop position. To do so:

- a) Roll the throttle fully left (increase) ([Figure 9.1](#)) from FULL CLOSE ([Figure 9.2](#), 1) to FULL OPEN position by pressing and holding [PgUp].
- b) Roll the throttle back to the right (decrease) by pressing and holding [PgDn] until the idle stop ([Figure 9.2](#), 2) is reached and the throttle cannot rotate further past the detent.
- c) Press [RWIN + T] to engage the IDLE RELEASE switch on the collective control box.
- d) Press [PgDn] to roll the throttle just right (decrease) of the idle position. The throttle will now be set as near as possible (on decrease side) to the engine idle stop position as required for engine start.
- e) Press [RWIN + T] again to release the IDLE RELEASE switch on the collective control box.

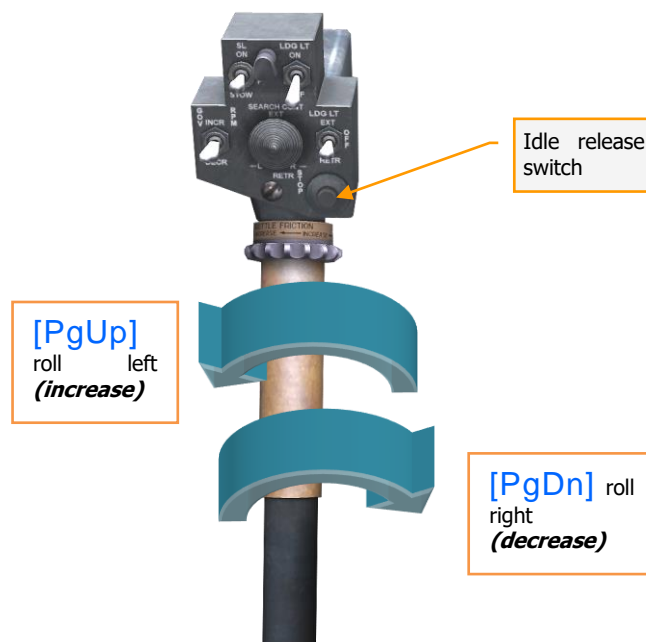

Figure 9.1. Direction of Rotation of the Throttle.



1. FULL CLOSE position

2. IDLE STOP position

Figure 9.2. FULL CLOSE and IDLE STOP Positions.

3. Engine – Start as follows:

- a) Start switch – press and hold [\[Home\]](#); note start time.

Note. DC voltmeter indication. Battery starts can be made when voltages less than 24 volts are indicated, provided the voltage is not below 14 volts when cranking through 10 percent N1 speed.

- b) Main rotor – Check that the main rotor is turning as N1 reaches 15 percent. If the rotor is not turning, abort the start.
- c) Start switch – Release at 40 percent N1 or after 40 seconds, whichever occurs first.
- d) Throttle – Slowly advance past the engine idle stop ([\[PgUp\]](#)) to the engine idle position. Manually check the engine idle stop by attempting to close the throttle ([\[PgDwn\]](#)). Ensure the throttle is kept in idle power as the engine is being spooled up.
- e) Setting the throttle past idle during engine start can result in engine damage or fire!
- f) N1 68 to 72 percent. Hold a very slight pressure against the engine idle stop during the check. A slight rise in N1 may be anticipated after releasing pressure on throttle.

Note. The copilot attitude indicator should be caged and held momentarily as inverter power is applied.

- 4. INVTR switch – MAIN ON [\[LShift+U\]](#).
- 5. Engine and transmission oil pressures – Check.
- 6. GPU – Disconnect.

9.1.3. Engine Runup

1. Avionics – ON.
2. STARTER GEN switch – STBY GEN [LShift+X].
3. Systems – Check as follows:
 - a) FUEL.
 - b) Engine.
 - c) Transmission.
 - d) Electrical.
 - (1) AC – 112 to 118 Volts.
 - (2) DC – 27 to 28.5 Volts.
4. RPM – 6600. As throttle is increased, the low rpm audio and warning light should be off at 6100 to 6300 rpm.

9.2. Take-off and hover

9.2.1. Before Take-off

Immediately prior to take-off the following checks shall be accomplished:

1. RPM – 6600.
2. Systems – Check engine, transmission, electrical and fuel systems indications.
3. Avionics – As required.

9.2.2. Takeoff to hover

Note. During take-off and at any time the helicopter skids are close to the ground, negative pitch attitudes (nose low) of 10° or more can result in ground contact of the WSPS lower cutter tip. Forward cg, high gross weight, high density altitude, transitional lift setting, and a tailwind increase the probability of ground contact.

A. Required

- a) Pretakeoff check completed prior to beginning maneuver.
- b) Vertical ascent.
- c) Constant heading.
- d) Stabilize at a 3-foot hover.

B. Recommendations for aircraft control during takeoff

Neutralize the cyclic control stick. Observe the view ahead and outside the cockpit. Use the area about 15-20 feet in front of the helicopter for visual reference, moving your view side to side. Slowly move the collective up until the helicopter lifts off the ground and establish a hover at an altitude of

approximately 3 feet. Typically the toes of the skids will lift first, followed by the right skid, and lastly the left skid.

One of the more difficult elements of a takeoff is maintaining the takeoff heading and attitude, while minimizing deviation from the takeoff point over the ground and maintaining a vertical ascent. As the collective is raised, the helicopter will experience changes in balance, requiring the pilot to be prepared to perform the following control inputs to compensate:

- a) increased thrust of the main rotor and reduced ground friction on the skids will result in a right yaw tendency, requiring measured input on the LEFT anti-torque pedal (about $1/4 - 1/3$ of its movement range) to increase thrust of the tail rotor and balance the yaw tendency to maintain heading;
- b) increased thrust of the tail rotor and reduced ground friction on the skids will produce a tendency for the helicopter to slide right, requiring measured input of the cyclic to the LEFT (about $1/6 - 1/5$ of its movement range) to displace the thrust vector of the main rotor to the left to compensate the increased tail rotor thrust and prevent any side slipping motion of the helicopter;
- c) in addition to the above, as the helicopter lifts off the ground, it will have a tendency to nose down due to the displacement of the main rotor plane or motion relative to the longitudinal axis of the helicopter, requiring a measured PULL of the cyclic (about $1/6 - 1/5$ of its movement range) to displace the thrust vector of the main rotor backward and prevent any nose down and forward movement of the helicopter;
- d) once free from ground contact and balanced on the main rotor axis in flight, the helicopter will have a tendency to pitch up (nose up), resulting in backward movement of the helicopter and requiring a measured PUSH on the cyclic (approximately back to the neutral position) to displace the thrust vector of the main rotor forward and prevent any backward movement of the helicopter.

After liftoff is accomplished, maintain the helicopter heading and attitude in a straight vertical ascent to approximately 3 feet of altitude. Stabilize at this altitude by a slight lowering of the collective ($1/10 - 1/20$ of its movement range), while at the same time reducing the left pedal input (about $1/6 - 1/8$ of its movement range) and the left cyclic input (by about $1/8 - 1/10$ of its movement range) (see [Figure 9.3](#)..[Figure 9.5](#)).

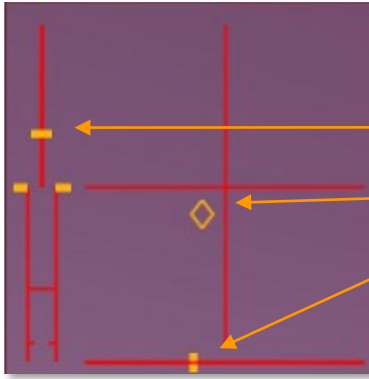

Figure 9.3. Control positions for balancing helicopter during hover.
 Conditions: Sea level, FAT +15°C, empty (7260 lbs).

Collective

Cyclic

Pedals

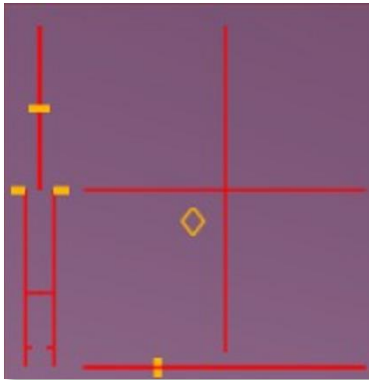

Figure 9.4. Control positions for balancing helicopter during hover.
 Conditions: Sea level, FAT +15°C, weight 9500 lbs.

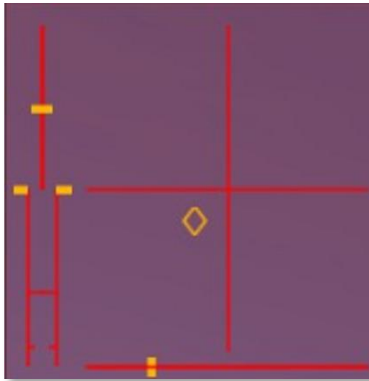

Figure 9.5. Control positions for balancing helicopter during hover.
 Conditions: Sea level, FAT +40°C, weight 9500 lbs.

When attempting a hover, remember that the UH-1H is not equipped with any automated flight control systems. This means that all forward/back and left/right tendencies need to be corrected with measured input of the cyclic, performed in short, smooth, and most importantly – returned movements. To aid with timely control inputs in the initial stages, remember to quickly glance left and right outside the cockpit ahead of the helicopter. To simplify the control problem, minimize movement of the collective, as any collective adjustments require coordinated inputs of the cyclic and pedals to maintain balance in flight.

9.2.3. Hovering turns

A. Required

- a) Altitude at constant 3-foot hover.

- b) Remain over pivot point.
- c) Constant rate of turn (maximum rate of turn of 360° in 15 seconds is recommended for training).

B. Recommendations for implementation

Prior to initiating the turn, look toward the side of the turn to ensure the area is free of obstacles to avoid a possible collision. Slightly depress the corresponding pedal (1/10 – 1/8 of its movement range). Attain a desired rate of yaw. Once the desired rate of yaw is attained, lessen the pedal input (return to a position of 1/15 – 1/20 of its movement range). A well executed turn should be performed around or near the main rotor vertical axis.

Maintaining the center point of the turn, altitude and yaw rate can be difficult, requiring the pilot to be prepared to perform the following control inputs to compensate for control instability:

- a) Due to the unbalanced nature of forces and moments during a hovering turn, the helicopter will not turn exactly over the main rotor vertical axis, but with a small radius of turn (30 – 50 feet), requiring cyclic control input in addition to pedal input to control the turn.
- b) When initiating a LEFT hovering turn, the pilot first adds left pedal, which increases tail rotor thrust and produces a slight bank to the right (1 – 3°) and slip to the right. Slight LEFT cyclic (1/8 – 1/10 of its movement range) is required to compensate for these tendencies and maintain the turning center point near the main rotor vertical axis. In addition, the transfer of power to the tail rotor produces a reduction in main rotor RPM (by 3 – 5 RPM) in the initial moments after input of the left pedal (when left pedal input is significant), leading to a slight loss of altitude (0.5 – 1.5 ft). It may take the engine governor up to 2 – 4 seconds to compensate and return the main rotor RPM to its starting value, at which point the helicopter may experience a slight climb rate (depending on the rate of yaw and available engine power). The climbing tendency occurs due to the increased velocity of the main rotor blades when combined with the helicopter's own rate of yaw relative to the surrounding air. The extent of all of the dynamic tendencies described depends on the aggressiveness of pedal input and the established rate of yaw.
- c) When initiating a RIGHT hovering turn, the pilot first adds right pedal, which decreases tail rotor thrust and produces a slight bank to the left (1 – 3°) and slip to the left. Slight RIGHT cyclic (1/8 – 1/10 of its movement range) is required to compensate for these tendencies and maintain the turning center point near the main rotor vertical axis. In addition, the transfer of power away from the tail rotor produces an increase in main rotor RPM (by 3 – 5 RPM) in the initial moments after input of the right pedal (when right pedal input is significant), leading to a slight increase of altitude (0.5 – 1.5 ft). It may take the engine governor up to 4 – 5 seconds to compensate and return the main rotor RPM to its starting value, at which point

the helicopter may experience a slight sink rate (depending on the rate of yaw and rotor RPM). The sinking tendency occurs due to decreased velocity of the main rotor blades when the helicopter's rate of yaw is subtracted from the combined velocity relative to the surrounding air. The extent of all of the dynamic tendencies described depends on the aggressiveness of pedal input and the established rate of yaw.

When performing hovering turns, the pilot has to continuously use measured cyclic control to balance the dynamic tendencies in bank and pitch, making small, but frequent adjustments of approximately $1/5 - 1/2$ inch once to twice per second and use measured pedal input to maintain a desired rate of yaw.

When performing a hover at maximum takeoff weight, in conditions of high altitude or high temperatures, when the main rotor cannot rise past 314 RPM at an altitude of 3 ft (which indicates the engines are operating at maximum power), a left turn will invariably lead to a loss of altitude, because the added power transferred to the tail rotor will be impossible to compensate to maintain main rotor RPM. On the other hand, a right turn will slightly unload the tail rotor and transfer power to the main rotor, providing an additional 3 – 5 RPM and producing a climb rate. This peculiarity of conventional helicopters is often employed by pilots operating in extreme conditions where performance is very limited, such as the hot and humid climate of Vietnam and mountains of Afghanistan.

9.2.4. Sideward flight

A. Required

- a) Altitude at constant 3-foot hover.
- b) 90-degree clearing turn in direction of sideward flight.
- c) Constant rate of movement (not to exceed 5 knots).
- d) Flightpath perpendicular to heading.

B. Recommendations for implementation

To initiate sideward flight, slightly add cyclic ($1/10 - 1/8$ of its movement range) in the desired direction. Maintain heading using the pedals, altitude using collective control, and monitor airspeed visually by watching the ground.

Maintaining heading and altitude can be difficult, requiring the pilot to be prepared to perform the following control inputs to compensate for control instability:

- a) The helicopter will tend to weathervane into the direction of flight, requiring measured pedal input in the opposite direction ($1/10 - 1/8$ of its movement range) to maintain heading.
- b) The tilt of the main rotor relative to the ground will reduce the vertical lift component, resulting in a loss of altitude and requiring increased collective to maintain altitude.

- c) To stop the helicopter at a desired point, set the cyclic control to the opposite side ($1/8 - 1/6$ of its movement range) approximately 4 – 8 ft ahead of the desired stopping point. As speed is reduced, return the cyclic to a near hovering position.

When performing sideward flight, the pilot has to continuously use measured cyclic control to balance the dynamic tendencies in bank and pitch, making small, but frequent adjustments of approximately $1/5 - 1/2$ inch once to twice per second and use measured pedal input to maintain heading perpendicular to the direction of flight. Aggressive inputs of the cyclic will require similarly aggressive inputs of the collective and pedals to maintain coordinated flight.

9.2.5. Rearward flight

1. Required

- a) Altitude at constant 3-foot hover.
- b) 90-degree clearing turn in direction of sideward flight.
- c) Constant rate of movement (not to exceed 5 knots).
- d) Flightpath of 180° to heading.

2. Recommendations for implementation

To initiate rearward flight, increase collective ($1/10 - 1/8$ of its movement range) and simultaneously slightly pull back the cyclic control ($1/10 - 1/8$ of its movement range). Use the pedals to maintain heading and the collective to maintain altitude. Monitor speed by looking at the ground and control heading by finding a visual landmark.

Maintaining heading and altitude can be difficult, requiring the pilot to be prepared to perform the following control inputs to compensate for control instability:

- a) the helicopter will tend to weathervane into the direction of flight, resulting in a continual "waving" of the tail up to $10 - 15^\circ$, requiring measured and more frequent than normal pedal input ($1/10 - 1/8$ of its movement range) to prevent the tail from yawing more than $\pm 5^\circ$;
- b) the tilt of the main rotor relative to the ground will reduce the vertical lift component, resulting in a loss of altitude and requiring increased collective to maintain altitude;
- c) as reverse speed reaches 8 – 10 knots, the nose will begin to rise as a result of the increased airflow over the synchronized elevator pushing the tail down. Compensate for this with a slight adjustment of the cyclic forward;
- d) to stop the helicopter at a desired point, set the cyclic control to the opposite side ($1/8 - 1/6$ of its movement range) approximately 6 – 8 ft ahead of the desired stopping point. As speed is reduced, return the cyclic to a near hovering position.

When performing rearward flight, the pilot has to continuously use measured cyclic control to compensate the dynamic tendencies in bank and pitch, making small, but frequent adjustments of approximately $1/5 - 1/2$ inch once to twice per second and use measured pedal input to maintain heading.

9.2.6. Landing from hover

A. Required

1. Constant heading.
2. Vertical descent.

B. Recommendations for aircraft control during landing

To initiate a landing from a hover, slowly reduce collective ($1/10 - 1/8$ of its movement range) while simultaneously compensating for a left yaw tendency with input of the right pedal. Typically the left skid will make ground contact first, followed by the right skid, and then the skid toes.

Maintaining heading, vertical approach path and preventing any slippage can be difficult, requiring the pilot to be prepared to perform the following control inputs to compensate for control instability when lowering the collective and when contacting the ground:

- a) The helicopter will have a tendency to yaw left due to decreased thrust of the main rotor, requiring a measured input of the RIGHT pedal ($1/8 - 1/6$ of its movement range) to reduce the tail rotor thrust and compensate the yaw tendency.
- b) Decreased thrust of the tail rotor will produce a tendency for the helicopter to slide left (due to the left component of the main rotor thrust vector present in a hovering state), requiring measured input of the cyclic to the RIGHT (about $1/6 - 1/5$ of its movement range) to reduce the left component of the main rotor thrust vector and compensate the reduced tail rotor thrust to prevent any side slipping motion of the helicopter.
- c) As the helicopter nears the ground, ground effect will result in a reduced sink rate or a stabilized altitude, requiring an additional slight reduction of the collective control ($1/10 - 1/8$ of its movement range) to "push through" the ground effect and continue the descent. As before, reduction of the collective requires additional input on the pedals to maintain heading and cyclic to prevent slippage.
- d) Upon ground contact, the fuselage will take on a ground attitude, which will move the thrust vector of the main rotor forward, resulting in a tendency of the helicopter to slide forward, requiring a measured pull of the cyclic BACK ($1/6 - 1/5$ of its movement range) to prevent any forward skid.

During the approach, the aggressiveness of cyclic and pedal input should be progressively reduced, but the frequency increased (up to 2 – 2.5 inputs per second on the cyclic).

After ground contact, continue to operate the controls smoothly until collective control is minimized.

When performing a vertical descent from an altitude of 15 ft or higher, ensure a sink rate less than 8.3 ft/sec (500 ft/min). A sink rate greater than 8.3 ft/sec can result in a vortex ring state (VRS), during which the sink rate can rise uncontrollably within 1 – 2 seconds up to 2000 ft/min, which will lead to a hard landing and possible damage or destruction of the helicopter.

9.2.7. Normal takeoff

To perform a normal takeoff, first look ahead approximately 100 – 150 feet. Carefully push the cyclic forward by 1/10 – 1/8 of its movement range to set a pitch angle of -4 – -6° . Because of the forward shift of the thrust vector of the main rotor, its vertical component will be reduced, leading to a loss of altitude. To compensate for this, raise the collective by approximately 1 – 1.5° .

Transitional maneuvers involving acceleration or deceleration produce balance changes in all axes, which require the pilot to control the pitch and roll using the cyclic, and control yaw and heading using the pedals.

Maintaining heading, pitch, and preventing any slippage can be difficult, requiring the pilot to be prepared to perform the following control inputs to compensate for control instability:

WHEN SPEED REACHES 15 – 20 KNOTS, THE HELICOPTER WILL DEMONSTRATE THE FOLLOWING TENDENCIES:

- a) "float" and nose down (due to increasing main rotor thrust as it moves from axial to oblique flow, as well as the increasing aerodynamic force, pointed downward, of the synchronized elevator), requiring a forward push of the cyclic to "nudge" the nose down and maintain a constant pitch angle.
- b) left roll (due to increasing dissymmetry of lift, which sinks the main rotor cone leftward), requiring a measured right input of the cyclic to prevent any rolling.

WHEN SPEED REACHES 25 – 30 KNOTS, THE HELICOPTER WILL DEMONSTRATE THE FOLLOWING TENDENCIES:

- c) left yaw (due to increasing tail rotor thrust as oblique flow increases, as well as the increasing aerodynamic force, pointed rightward, of the vertical stabilizer), requiring a reduced input of the left pedal by 1/15 – 1/10 of its movement range to maintain heading. The reduced thrust of the tail rotor will unbalance the rolling moments and lead to a slight left roll, requiring measured input of the cyclic to the right to compensate for the roll.

WHEN SPEED REACHES 40 KNOTS, THE HELICOPTER WILL DEMONSTRATE THE FOLLOWING TENDENCIES:

- d) Left roll (due to the continuing increase in the dissymmetry of lift), requiring a measured input of the cyclic to the right by about 1/10 – 1/8 of its movement range.

As helicopter airspeed increases, the dissymmetry of lift increases as well (advancing blades on the right side flap upward while retreating blades on the left side flap downward due to reduced lift as a result of lower retreating blade airspeed), producing an increasing leftward drop of the main rotor cone and requiring increasing input of the cyclic to the right to compensate. However, the cyclic input is minimized by the specially-designed vertical stabilizer, which is canted to produce a rightward rolling moment with increasing airspeed.

When approaching 120 knots (at low altitudes), the dissymmetry of lift begins to approach critical values as the retreating blades on the left side (270 – 300° from the longitudinal axis) begin to approach retreating blade stall conditions, leading to spontaneous left rolling. Such a condition requires a reduction in airspeed by a slight pull of the cyclic back (about 1/10 – 1/8 of its movement range).

Note.

Maximum Performance.

A take-off that demands maximum performance from the helicopter may be necessary because of various combinations of heavy helicopter loads, limited power and restricted performance due to high density altitudes, barriers that must be cleared and other terrain features. The decision to use either of the following take-off techniques must be based on evaluation of the conditions and helicopter performance. The copilot (when available) can assist the pilot in maintaining proper rpm by calling out rpm and torque power changes, thereby allowing the pilot more attention outside the cockpit.

A. Coordinated Climb. Align the helicopter with the desired take-off course at a stabilized hover altitude of approximately three feet (skid height). Apply forward cyclic pressure smoothly and gradually, while simultaneously increasing collective pitch to begin coordinated acceleration and climb. Adjust pedal pressure as necessary to maintain the desired heading. Maximum torque available should be applied (without exceeding helicopter limits) as the required attitude is established that will permit safe obstacle clearance. The climb out is continued at that attitude and power setting until the obstacle is cleared. After the obstacle is cleared, adjust helicopter attitude and collective pitch as required to establish a climb at the desired rate of climb and airspeed. Continuous coordinated application of control pressures is necessary to maintain a trimmed heading, flight path, airspeed, and rate of climb. This technique is desirable when OGE hover capability exists. Take-off may be made from the ground by positioning the cyclic control slightly forward of neutral prior to increasing collective pitch.

B. Level Acceleration. Align the helicopter with the desired take-off course at a stabilized hover altitude of approximately three feet (skid height). Apply forward cyclic pressure smoothly and gradually while simultaneously increasing collective pitch to begin acceleration at approximately 3 to 5 feet (skid height). Adjust pedal pressure as necessary to maintain the desired heading. Maximum torque available should be applied (without exceeding helicopter limits) prior to accelerating through effective translational lift. Additional forward cyclic pressure will be necessary to allow for level acceleration to the desired climb airspeed. Approximately five knots prior to reaching the desired climb airspeed, gradually release forward cyclic pressure and allow the helicopter to begin a constant airspeed climb to clear any obstacles. Care must be taken not to decrease airspeed during the climb out since this may result in the helicopter descending. After the obstacle is cleared, adjust helicopter attitude and collective pitch as required to establish a climb at the desired rate of climb and airspeed. Continuous coordinated application of control pressures is necessary to maintain a trimmed heading, flight path, airspeed and rate of Climb. Take-off may be made from the ground by positioning the cyclic control slightly forward of neutral prior to increasing collective pitch.

C. Comparison of Techniques.

Where the two techniques yield the same distance over a fifty-foot obstacle, the coordinated climb technique will give a shorter distance over lower obstacles and the level acceleration technique will give a shorter distance over obstacles higher than fifty feet. The two techniques give approximately the same distance over a fifty-foot obstacle when the helicopter can barely hover OGE. As hover capability is decreased, the level acceleration technique gives increasingly shorter distances than the coordinated climb technique.

In addition to the distance comparison, the main advantages of the level acceleration technique are:

- (1) It requires less or no time in the Avoid area of the height-velocity diagram;
- (2) Performance is more repeatable since reference to attitude, which changes with loading and airspeed, is not required;
- (3) At the higher climb out airspeeds (30 knots or greater), reliable indicated airspeeds are available for accurate airspeed reference from the beginning of the climb out, therefore minimizing the possibility of descent.

The main advantage of the coordinated climb technique is that the climb angle is established early in the take-off and more distance and time are available to abort the take-off if the obstacle cannot be cleared. Additionally, large attitude changes are not required to establish climb airspeed.

Slingload.

The slingload take-off requiring maximum performance (when OGE hover is not possible) is similar to the level acceleration technique, except the take-off is begun and the acceleration made above 15 feet. Obstacle heights include the additional height necessary for a 15-foot sling load.

9.3. Climb

After take-off, select the speed necessary to clear obstacles. When obstacles are cleared, adjust the airspeed as desired (60 knots are recommended at sea level) at or above the maximum rate of climb airspeed. [Figure 9.6](#) shows control positions for balancing the helicopter during climb.

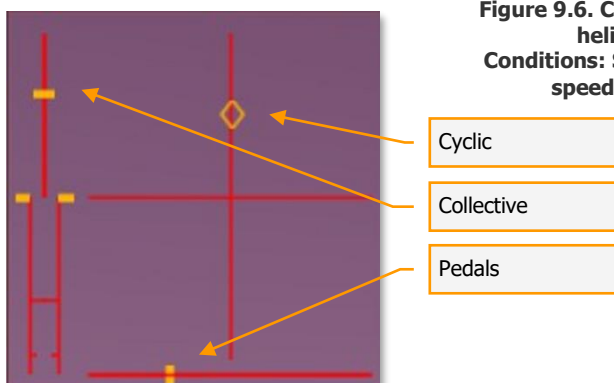

9.4. Cruise

When the desired cruise altitude is reached, adjust power as necessary to maintain the required airspeed (80 - 90 knots are recommended at sea level). [Figure 9.7](#) shows control positions for balancing the helicopter during level flight.

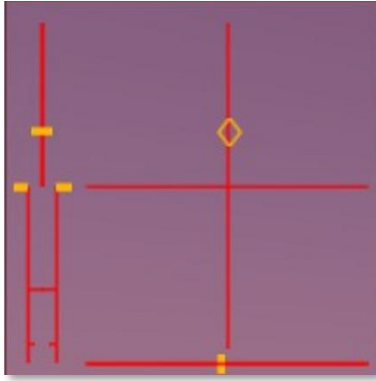

Figure 9.7. Control positions for balancing helicopter during level flight.
 Conditions: Sea level, FAT +15°C, empty, speed 90 knots.

9.5. Descent and landing

When preparing for landing, the approach should be planned so that descent and deceleration is performed against the wind or with a crosswind from the right.

Descent

From a starting altitude of 400 – 450 ft, plan for an approach distance of 4500 – 5000 ft to the landing hover point. As experience builds, the approach distance can be reduced to 3500 – 4000 ft. When flying a visual approach pattern, the turn to final should be started when the touchdown point is approximately 15 - 20° off the nose of the helicopter and performed with a bank of 15 - 20° to start (Figure 9.8) the final approach at approximately 80 knots.

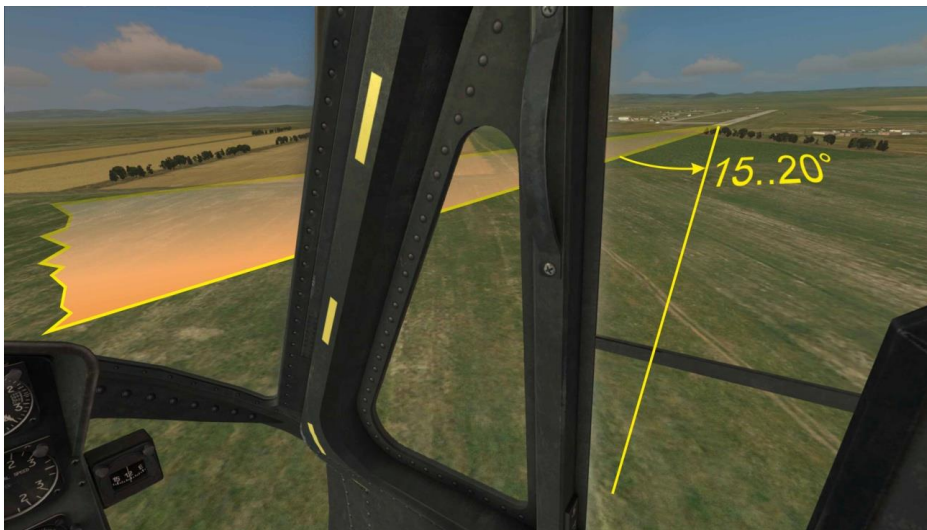

Figure 9.8. Lining up for Final Approach.

When descending for a landing, the glideslope can be approximated according to the following guidelines:

Descent parameters			
Distance	4500 - 4000 ft (1500 m)	3000 ft (1000 m)	1500 ft (500 m)
Speed [knots]	80	60	40..30

Altitude [ft]	500..450	350..300	200..150
Descent [ft/min]	300..500	400..600	200..300

After completing the turn to final approach, set up and control the descent. As the collective is lowered and the rate of descent reaches 500 – 600 ft/min, the airflow dynamics over the elevator will tend to drop the nose down and increase airspeed. To counteract this, pull the cyclic back about 1/8 – 1/6 of its movement range. [Figure 9.9](#) shows control positions for balancing the helicopter during descent.

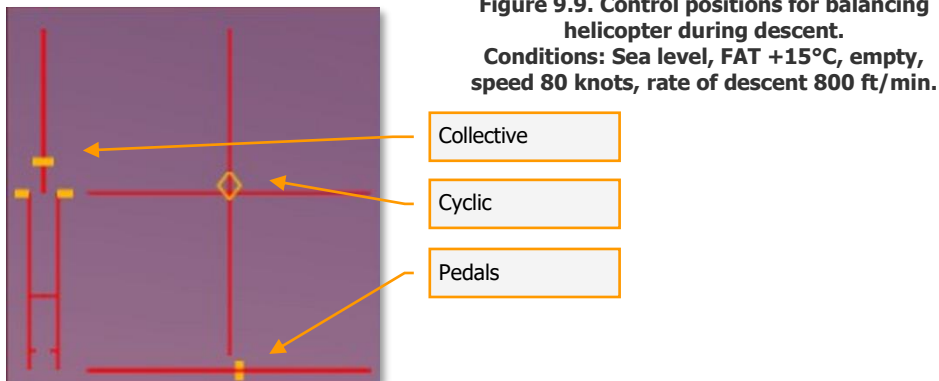

Maintain the glideslope by controlling the position of the landing point on the canopy of the cockpit. If the landing point "crawls" upward on the canopy, the glideslope is too steep and the approach will be short of the desired point. To counteract this, raise the collective slightly to reduce the rate of descent. If the landing point "crawls" downward on the canopy, the glideslope is too shallow and the approach will overshoot the landing point. To counteract this, reduce collective slightly to increase the rate of descent, but maintain it under 800 ft/min. If a greater rate of descent is necessary to enter the glideslope, but the distance to the landing point is less than 2500 ft, abort the approach and execute a go-around for a second attempt.

Special considerations for decelerations.

Set pitch to +2 - +3° with a slight pull of the cyclic, simultaneously lowering the collective to maintain the desired rate of descent. The approximate rate of deceleration is recommended as follows: for every 50 ft of altitude, the airspeed should drop by 7 – 10 knots. Keep in mind however; the rate of deceleration depends on the pitch angle and entry speed. For example, for the same pitch angle, the rate of deceleration from 80 down to 50 knots is considerably lower (approximately 15 seconds) than the rate of deceleration from 50 knots down to 10 – 15 knots (approximately 5 – 7 seconds). This requires a slight adjustment of the cyclic forward (about 1/10 – 1/20 of movement range) with a corresponding increase in collective to prevent a "sinking" of the helicopter.

During decelerations, the helicopter will demonstrate the following tendencies:

- a) From 80 down to 55 – 50 knots, the deceleration is normal and the helicopter flies down the glideslope toward the touchdown point smoothly and predictably, requiring little to no adjustment in power;

- b) After passing through 55 – 50 knots, the helicopter undergoes a change in dynamics, requiring greater engine power as airspeed is reduced in order to maintain the desired rate of descent. If power is not applied by raising the collective as airspeed is reduced, the helicopter will begin to "sink", increasing the rate of descent to above 1000 ft/min, which can result in an entry into a vortex ring state (VRS) at airspeeds of 10 – 15 knots, leading to a possible crash.

Rapid decelerations achieved by a large pull of the cyclic and drop of the collective should be avoided at airspeeds of 60 – 20 knots. Doing so can lead to a rapid increase in rotor RPM due to increased airflow over the main rotor, which can produce a number of negative consequences: engine governor reduces engine power to compensate for increased rotor RPM; once airspeed reaches 25 – 20 knots, the helicopter tends to "sink", requiring a rapid increase in collective to prevent an uncontrolled descent; the engine is incapable of providing the power required to maintain rotor RPM at the increased collective setting rapidly enough; the increased collective setting combined with an underpowered regime of the engine results in rotor underspeed (below 314 RPM); the helicopter begins a spontaneous descent the pilot is unable to stop; a right yaw tendency may also appear as torque increases with increased engine RPM and tail rotor effectiveness is reduced with lower rotor RPM.

In summary: the pilot has a margin of error when flying a landing approach where he can deviate somewhat from the guidelines described above. However this margin is reduced as the free air temperature (FAT) is raised, helicopter weight is increased, and the pressure altitude of the landing site is increased.

Landing from a Hover (see [9.2.6](#))

Run-on Landing

A run-on landing may be used during emergency conditions of hydraulic power failure, some flight control malfunctions, and environmental conditions. The approach is shallow and flown at an airspeed that provides safe helicopter control. Airspeed is maintained as for normal approach except that touchdown is made at an airspeed above effective translational lift. After ground contact is made, slowly decrease collective pitch to minimize forward speed. If braking action is necessary, the collective pitch may be lowered as required for quicker stopping.

9.6. Engine Shutdown

AUTOSTOP ENGINE: [[LWIN+End](#)].

1. Throttle Engine idle for two minutes ([\[PgDown\]](#) for min position throttle).
2. FORCE TRIM switch ON.
3. STARTER GEN switch START [[LShift+X](#)].
4. Throttle – Off. To rotate the throttle from IDLE to OFF, perform the following steps:

5. Press [RWIN + T] to engage the idle stop release.
6. Press and hold [PgDn] to roll the throttle fully right (decrease) until it reaches the OFF position and fuel flow to the engine is cut off.
7. Center Pedestal switches Off:
 - a) FUEL [F] (in this game, the engine stops).
 - b) Avionics.
8. Overhead switches Off:
 - a) INVTR [LShift+I].
 - b) PITOT HTR [RAlt+P].
 - c) LTS: Navigation lights [RCtrl+L], Landing light [RCtrl+], Search light [RAlt+;].
 - d) MISC (switches of miscellaneous Control Panel).
 - e) INST LTG.
9. BAT [LShift+P].

9.7. Autorotation. Practical part

An autorotation (theory – see [3.1.13](#)) is used to land the helicopter in a variety of situations where normal flight control becomes impossible. Among these may be a malfunction or complete failure of the engine, tail rotor system, tail rotor drive system, or other problems requiring minimizing torque from the main rotor. The UH-1H has excellent autorotation characteristics, which helps perform autorotation landings safely. This is made possible by the low disc loading of the main rotor – from 3.90 lbs/ft² (19 kg/m²) for an empty helicopter up to 5.24 lbs/ft² (25.5 kg/m²) for a fully loaded helicopter¹, as well as a heavy main rotor that carries a lot of inertia and potential energy. Here is how these factors were described by the UH-1 pilot Robert Mason in his book, *Chickenhawk*:

“The heavy, thudding noise of the main rotors – the characteristic wop-wop-wop sound – was caused by their huge size, 48 feet from tip to tip, and a 21-inch chord (width). With ballast weights at each blade tip, the whirling rotor system had tremendous inertia. The IP demonstrated this inertia with a trick that only a Huey could do. On the ground at normal rotor speed (330 rpm) he cut the power, picked the machine up to a four-foot hover, turned completely around, and set it back on the ground. Incredible! Any other helicopter would just sit there, not rising an inch, while the rotors slowed down. These big metal blades with the weights in the tips would serve me well in Vietnam. Their strength and inertia allowed them to chop small tree branches with ease”.

Because of these design features, learning to perform autorotation landing on the Huey is considerably easier than on most other helicopter types.

¹ As a comparison, the disc loading of the AH-64D is 5.95 lbs/ft² (29 kg/m²) for an empty helicopter and 11.61 lbs/ft² (56.7 kg/m²) when fully loaded.

A. Transitioning to autorotation

Typically the need to perform an autorotation arises suddenly while the pilot is focused on flight tasks not directly related to managing the power system. For example these might be: conducting visual scanning, maintaining formation, weapons employment, etc. Experience has shown that it can take from 2 to 5 seconds between a system malfunction and the start of corrective actions by the pilot. A safe autorotation landing begins with a timely recognition of the problem and immediate, appropriate control actions to transition into autorotation.

The greatest RPM drop occurs in cases of a complete engine failure during level flight with velocity above 80 knots or climb. A corrective control lag of 2-5 seconds can result in rotor RPM dropping to 280. In such cases, immediately perform the following steps:

- a) Restore the rotor RPM by lowering the Collective all the way down. If speed is above 70 knots, pull the Cyclic back to increase rotor RPM using the energy of the oncoming airflow, but maintain above 50 knots by adjusting the Cyclic forward as necessary.
- b) If transitioning from a hover at an altitude of 400 ft or greater, accelerate to 60 – 80 knots. At lower altitudes, make an effort to gain airspeed, but consider that accelerating and decelerating the helicopter will require short and accurate adjustments of the Collective and there is little room for error in control input.
- c) When reducing airspeed, control heading using the pedals.
- d) Maintain rotor RPM between 310 - 340 by carefully raising the Collective (1/10 – 1/20 of movement range) to reduce RPM and lowering it to increase RPM. Do not exceed 340 RPM.
- e) Maintain a glide speed of 60 – 90 knots.
- f) If in the transition to autorotation there is insufficient Cyclic pull range to affect the required pitch change necessary to maintain rotor RPM, increase Collective by 1/6 – 1/5 of its movement range. This will increase pitch authority. Once the desired glide speed of 60 – 90 knots is reached, the Collective can be reduced again in order to maintain main rotor RPM.

B. Autorotation descent

Descent parameters (airspeed and rotor RPM) for an autorotation landing are planned based on the desired goals of the pilot as determined before initiating autorotation – either to maintain a minimum rate of descent or maximum glide distance.

Figure 9.8 displays control positions for balancing the helicopter during autorotation.

MINIMUM RATE OF DESCENT. Minimum rate of descent is achieved using a glide speed of 55 – 65 knots (indicated). The rate of descent at these airspeeds should be 1400 – 1800 ft/min, while the glide distance should be 4.3 –

3.4x altitude. This descent can be used when altitude is greater than 1200 ft, and the pilot will be making an attempt to restart the engine in the air (so long as this is not forbidden), see [12.1.3](#).

MAXIMUM GLIDE DISTANCE. Maximum glide distance is achieved using a glide speed of 80 – 90 knots (indicated). The rate of descent at these airspeeds should be 1600 – 2400 ft/min, while the glide distance should be 5.3 – 3.6x altitude. This descent can be used when the landing point is at a considerable distance from the current position.

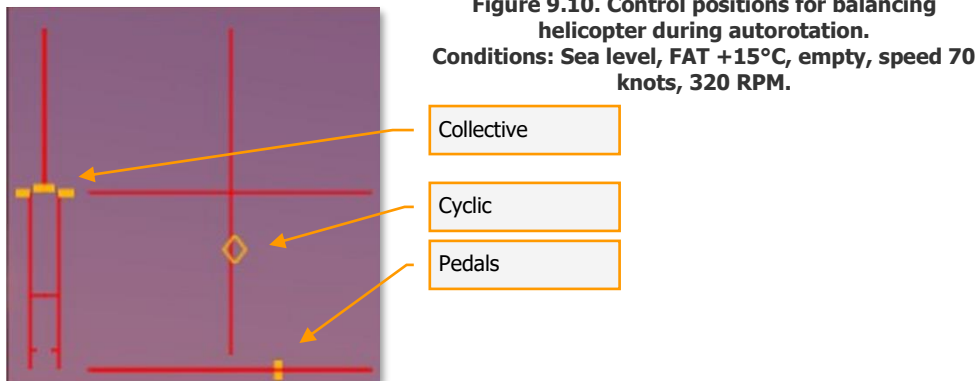

The rate of descent depends primarily on rotor RPM and to a lesser degree on helicopter weight. Rotor RPM, in turn, depend on the position of the Collective. If the Collective is set to minimum (down), rotor RPM will be 320 – 340 and the rate of descent will be close to maximum. With a slightly raised position of the Collective so that rotor RPM is 295 – 320, the rate of descent will be close to minimum.

As you can see, the higher rotor RPM correspond to higher rates of descent.

With increased helicopter weight, the rate of descent increases slightly: the difference in the rates of descent between an empty and fully loaded helicopter is +200 – 300 ft/min, if all else is equal.

C. Autorotation landing

Below will be described one of the methods that can be used for an autorotation landing. It is not the only possible method.

Choose a landing point that provides 300 – 500 ft of clear glidepath from any obstacles 100 ft or lower. Perform the following steps:

- a) Maintain 80 – 70 knots and 300 – 320 RPM until reaching an altitude of 200 – 150 ft. The rate of descent should be 2000 – 1700 ft/min. Keep in mind that approximately 12 – 15 seconds will pass between passing through 200 ft and landing;
- b) (t = 0 sec) from an altitude of 200 – 150 ft slowly (3 – 4 seconds) ([Figure 9.11](#)) pull the Cyclic back to set a pitch angle of +15 – 20° while ([Figure 9.12](#)):
 - (1) (t = +4 sec) rotor RPM will increase slightly (up to 330 – 340);
 - (2) rate of descent will decrease;

- (3) the helicopter may slide slightly left due to increased tail rotor lift;
- (4) any left sliding tendency should be corrected with slight right Cyclic adjustment ($1/8 - 1/10$ of movement range). Keep in mind that during an autorotation landing, the helicopter will generally be balanced with a slight right bank ([Figure 9.13](#)) – the slower the airspeed, the greater right bank (up to $1 - 3^\circ$).



Figure 9.11. Position of the Cockpit before Changing the Pitch.



Figure 9.12. Position of the Cockpit after Changing the Pitch.



Figure 9.13. Bank of the Helicopter during Speed Reduce.

- c) (t = +6 sec) focus eyes on the landing point;
- d) (t = +6 – 7 sec) from an altitude of 100..80 ft or when passing through 40 – 35 knots on the airspeed indicator (typically accompanied by a "sinking" of the helicopter), smoothly adjust the Cyclic forward (within about 3 – 4 sec) to set a landing pitch angle (from +15 – 20° to +4 – 6°) while simultaneously increasing Collective for the first time from its lowered position to 1/5 – 1/3 of its movement range within approximately 1 – 1.5 sec while:
 - (1) (t = +9 sec) main and tail rotor RPM will begin to drop, producing a left turning tendency, up to 10°;
 - (2) correct the left turning tendency by increasing right pedal by approximately 1/4 – 1/3 of its movement range, while slightly increasing right Cyclic to compensate for any left slide;
- e) (t = +10 – 15 sec) as the ground is nearer and based on the rate of descent increase collective once more up to 1/2 – 2/3 of its movement range within 3 – 4 sec. Be careful to prevent the helicopter from nosing over upon touchdown;
- f) the helicopter will touch down and possibly continue to roll for another 5 – 10 ft before coming to a stop.

WARNING! Never "yank" the collective all the way up! This can cause the helicopter to "float" up and enter a short hover at an altitude of 15 – 20 ft, before rotor RPM drops toward 200 and less, resulting in a drop down to the ground with a high sink rate and likely damage.

After touchdown, if the forward speed is excessive, pull the Cyclic back approximately 1/3 – 1/2 of its movement range to slow the helicopter using the main rotor. Once the helicopter is stopped, return the Cyclic to neutral and carefully (within 2 – 3 sec) lower the Collective all the way down.



10

COMBAT
EMPLOYMENT

10. COMBAT EMPLOYMENT

This chapter includes a description of UH-1H combat employment, [see also chapter 8 for ARMAMENT description](#).

As described in chapter 8, in addition to the two M60D door gunner machine guns, the UH-1H can be armed with two XM158 rocket pods with 7 70mm unguided rockets each (or XM159 pods with 19 rockets each) and two M134 6-barrel Gatling type Miniguns with 5400 rounds total. Unless noted otherwise, the remainder of the chapter will assume a standard combat load of 2xXM158 + 2xM134.

When learning to fly and employ the weapon systems, it is recommended that you enable the WEAPON STATUS indicator in the Options/Special/UH-1H page of the game menu [Figure 10.1..Figure 10.3](#) (remove/display WEAPON STATUS indicator together in hint AUTOPILOT MODE from/on the screen [LShift+LCtrl+H]).



Figure 10.1. Location of the WEAPON STATUS Indicators.

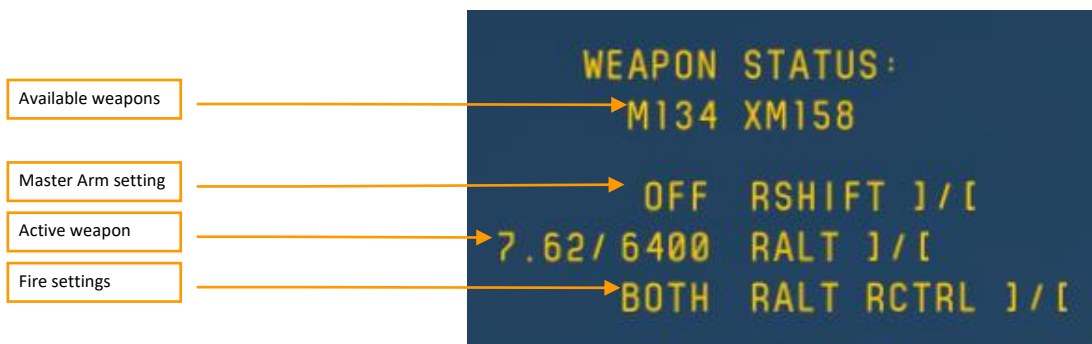

Figure 10.2. Weapon systems status indicator: OFF (not firing), 7.62 (M134 active weapon), 6400 (current balance cartridges), BOTH (fire simultaneously from two guns).



Figure 10.3. Weapon systems status indicator: ARMED (ready to open fire), 2.75 (XM158 active weapon), 38 (current balance rockets), X2 (two rockets from each launcher when you press the button once).

A. Flight control

When the helicopter is loaded with the standard combat load, the center of gravity (CG) shifts forward. This results in a greater amount of stick back pressure (pull) required by during takeoff and hover (1/3 – 1/4 of its movement range). Similarly, balanced forward flight is established with approximately 1/3 – 1/4 less forward stick than usual.

B. Cockpit procedures

Weapon systems are turned on prior to entering the combat area.

EMPLOYING THE XM158 (XM159) WEAPON SYSTEM (ROCKETS):

- a) Select the desired cockpit position (pilot or copilot) – [1], [2];
- b) Select "2.75" on the armament control panel – [RALT+[]];



- c) Set the desired number of rocket pairs to be fired on the armament control panel (1 to 7 from each launcher) – [RCTRL+]] and [RCTRL+[]];

d)



- e) Establish coordinated flight with minimizing descent (climb) and by minimizing sideslip (center the ball), which will maximize accuracy of fire;
- f) Set the aiming sight – [M] for left pilot's Flex sight or [RSHIFT+M] for the right pilot's XM60 Reflex sight. If playing as pilot (right side), you may need to turn on the reticel lamp by pressing [RCTRL+M]. The aiming reticle will appear (Figure 10.4). If playing

as copilot (left side), the flexible sight will move down and the sight reticle will appear ([Figure 8.10](#));

- g) Turn on the MASTER ARM switch – [RSHIFT+]] twice.



The helicopter is now prepared for rocket employment.



Figure 10.4. XM60 Reflex Sight Reticle Turned on.

When autopilot is engaged, the "Autopilot: ON" indication is added to the Weapons Status Indicator.

When playing as copilot (left side) and Flexible Mode is active, the autopilot is engaged automatically. This is designed to simulate the pilot maintaining the helicopter's attitude while the player operates the weapon system. The autopilot can be manually turned on and off with the [LWIN+A] key. The autopilot engages whenever the following conditions are true:

- a) Flexible Mode is active;
- b) The OFF-SAFE-ARMED switch is in the ARMED position.

Whenever the autopilot is engaged, the "Autopilot: ON" indication is added to the Weapons Status Indicator.

EMPLOYING THE M134 WEAPON SYSTEM (MINIGUNS):

- a) Select the desired cockpit position (pilot or copilot) – [1], [2];
- b) Select "7.62" on the armament control panel – [RALT+] ;
- c) Set the gun selector on the armament control panel to LEFT, RIGHT, or ALL as desired – [RAlt+RCtrl+] , [RAlt+RCtrl+[] ;



- d) Set the aiming sight – [M] for left pilot's Flex sight or [RSHIFT+M] for the right pilot's XM60 Reflex sight. If playing as pilot (right side), you may need to turn on the reticel lamp by pressing [RCTRL+M]. The aiming reticle will appear (Figure 10.4). If playing as copilot (left side), the flexible sight will move down and the sight reticle will appear (Figure 8.10);
- e) Turn on the MASTER ARM switch – [RSHIFT+]] twice (see above). The helicopter is now prepared for employment of the M134 miniguns.

Two aiming modes are available and can be set in the OPTIONS > SPECIAL > UH-1H menu: Camera Aiming ON and Camera Aiming OFF.

With Camera Aiming ON, the gun/gunsight is latched to the view camera, allowing you to aim with the mouse. To fire the gun, press the left mouse button or [Space]. You can toggle mouse-look and mouse-click mode by pressing [LAlt+C]. Note that you can use the mouse wheel to zoom the view in and out, as well as adjust the 3D position of the view by holding the mouse wheel down while moving the mouse.

With Camera Aiming OFF, the mouse or the keyboard numpad control the camera, while the [;], [,], [.] , [/] keys control the gun aim.

C. Lining up, aiming, and firing

Attempt to enter the target area undetected by maintaining nap-of-the-earth flight to the target area and avoid known air defense positions. When approaching to within 9000-8000 ft of the target, climb to acquire the target. The climb can be performed either by pulling the cyclic to raise the nose to a pitch angle of 10-15° or by increasing collective to gain altitude while maintaining pitch angles. The latter method is preferable as it maintains the target in view in front of the helicopter, prevents an increase of the helicopter's silhouette for enemy defenses, and minimizes loss of airspeed in the climb. After completing the climb, confirm the target's location and maneuver the helicopter to face the target.

When lining up on the target from a horizontal turn, begin leveling out of the turn at an angle to the target approximately equal to the angle of bank in the turn. I.e. when performing a turn with 40° of bank, begin to level out of the turn when the target is approximately 40° off the nose. Further:

- a) Once leveled out of the turn toward the target, maintain level flight at an airspeed of 80-100 knots and establish coordinated flight by minimizing sideslip (center the ball), which will maximize accuracy of fire;
- b) When employing rockets, place the aiming reticle over the target at a range of 6000 ft using the cyclic, open fire at a range of 5000-3000 ft.
- c) When employing the M134 miniguns, place the aiming reticle over the target at a range of 3000 ft, open fire at a range of 2500-1500 ft.

When firing the M134 miniguns in STOW mode or 2.75 rockets while continuing to manually fly the helicopter, a slight recoil force (70 kg) will produce a pitching down tendency. For long bursts, anticipate the recoil by aiming 0,5..1 pipper widths ABOVE the target.

D. Attack completion

When weapon fire is complete, perform an aggressive turn away from the target and reduce altitude while accelerating to maximum airspeed (110-120 knots). To minimize the probability of damage from enemy fire, perform defensive maneuvering by alternating left and right turns of approximately 40-50° for 4-5 seconds until the target is at a range of 3000-4000 ft.

Repeat attack passes as required.

When the attack is complete, set MASTER ARM to OFF and return to base.

E. Gunners artificial intelligence control

The left pilot, left and right door gunners can be commanded to autonomously engage targets using the guns. The left pilot employs the M134 'miniguns' in Flex mode, while the door gunners employ either the M60 or M134 guns, depending on the weapons fit (see also chapter [8.6](#) for ARMAMENT description).



11

PERFORM
SPECIAL TASKS

11. PERFORM SPECIAL TASKS

11.1. *Sling load usage*

The ability to use a Sling Load for carriage of external cargo has been implemented after release of version 1.2.8, see [Figure 11.1](#)



Figure 11.1. Fly with Sling Load.

11.1.1. Flight mission preparation for a Sling Load usage

To create a mission you'll need to make following actions (see Figure 11.2):

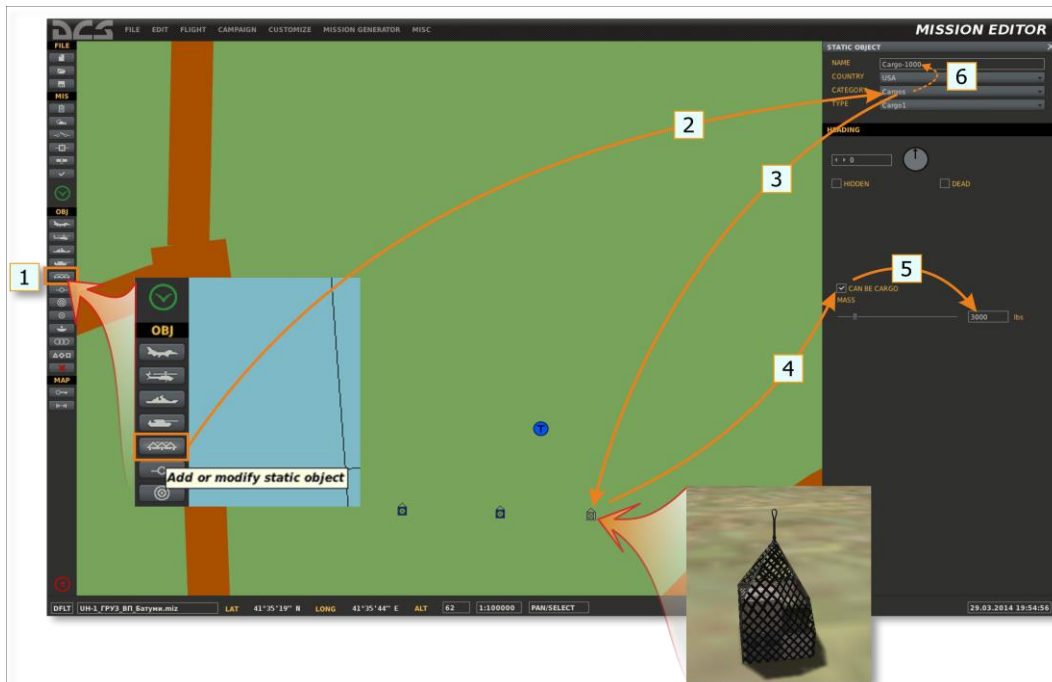
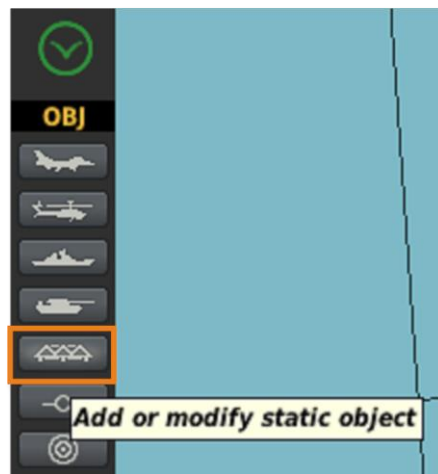

Figure 11.2. General Sling Load Mission Creation Plan.



1. Select static objects;
2. Select CATEGORY – "Cargos", TYPE – "Cargo-1":



3. Set this object(s) on the map (left button click);
4. Set the flag CAN BE CARGO (for an ability to select and hook your cargos during the game):

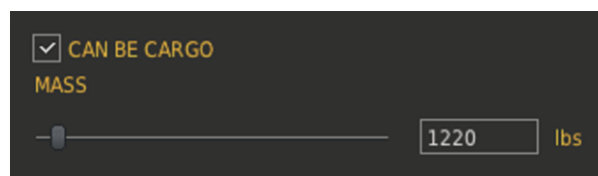

5. Set the required mass of cargo (about 500 kg (1100 lbs) is recommended for beginners);

6. Rename created object(s) (recommended), for example "LOAD-500" or "CARGO-650" for convenient in Game usage.

The UH-1H cargo hook maximum capacity is 4,000 pounds (1800kg).

11.1.2. Inflight usage (cargo selection, hooking and unhooking)

Let's review the list of actions needed to select, hook and unhook the cargo. At mission start we have several different weight cargos located in certain area.

It's needed to select the one, perform hooking, take off, flight to the designated unhooking area, approach the unhooking point and unhook the cargo.

PLAYER'S ACTIONS.

Selection of cargo

For making the cargo selection possible the "cargo selection zone" was implemented. That zone is connected to and moves with player's or AI helicopter (marked as a circles around helicopters No.1 and No.2). Thus cargos can be selected by player being inside mentioned zone only – at a distance less than "cargo selection zone" radius (see Figure 11.3, helicopter No.2)

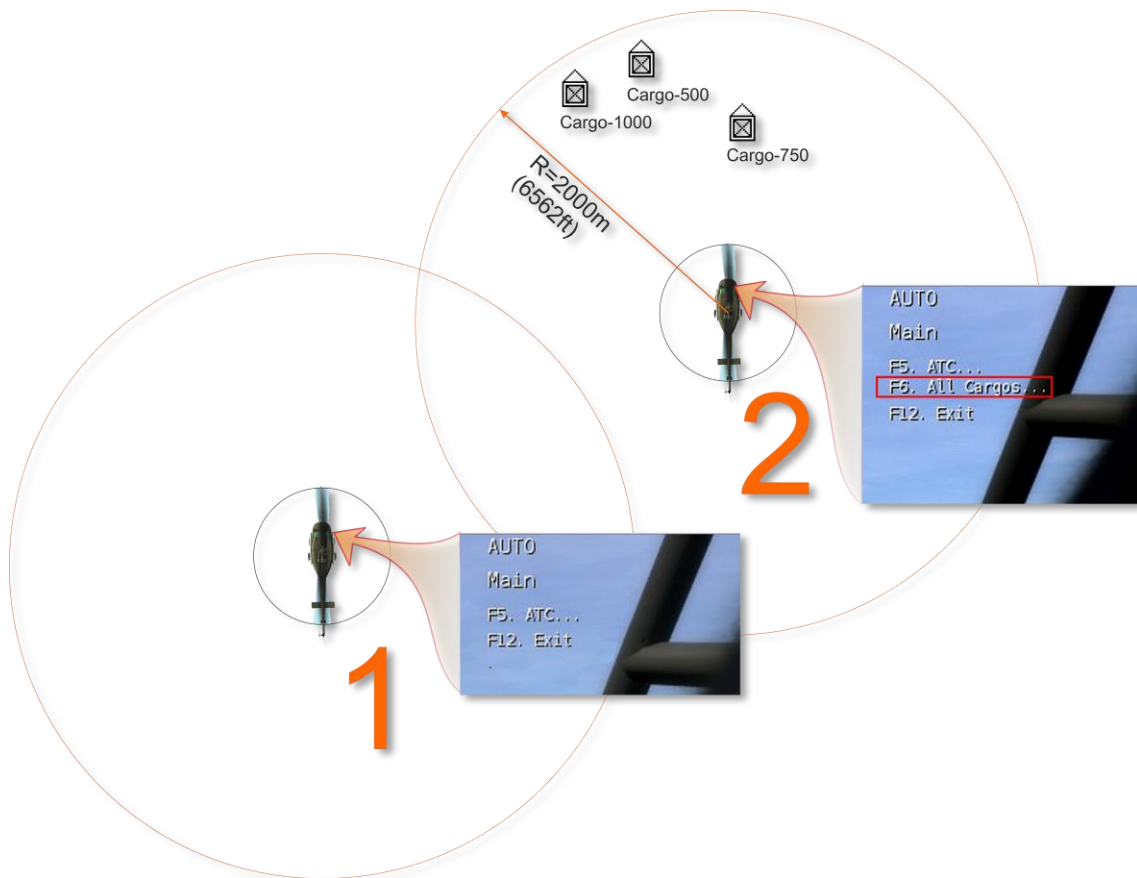

Figure 11.3. Cargo Selection Menu Appearance Dependent on Distance to Cargo.

Based on the testing experience, the "cargo selection zone" radius is set to 2,000m (6,562ft). If a helicopter is more than 2,000m away from the cargos, no cargo can be selected (helicopter menu #1). As soon as any cargo gets into the "cargo selection zone", which moves with the helicopter, a new menu item appears and additional page containing the list of cargos can be activated: [\] - > [F6] (helicopter menu #2). Now player can select any cargo from a list (see [Figure 11.4](#)):

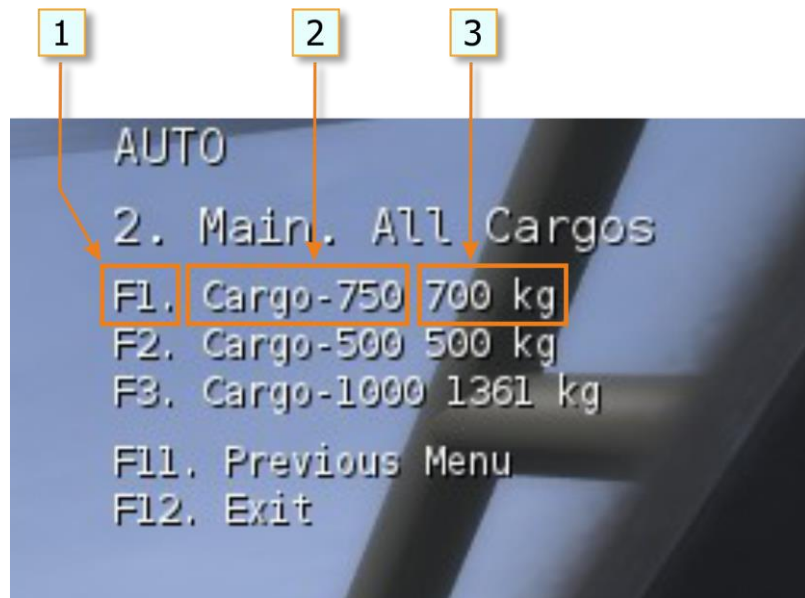

Figure 11.4. Menu for Selection of Cargo.

1. Selection key
2. Name of cargo
3. True weight of cargo

To select a cargo player needs to press one of the keys [F1...F10]. Simultaneously the cargo location will be marked with a smoke (white or red). Smoke marker will be visible only for the player who has selected this cargo (see Figure 11.5):



Figure 11.5. Autodesignation of Cargo Smoke Marker.

Hooking the cargo

After cargo selection the player has two options of picking it up. The first one (automatic) is from hovering above the cargo, the second one (manual, i.e. by

player command) – landing near by. When the first option is used, the function of automatic cargo hooking is activated (given the hovering is performed in needed manner, see below). If the second option is used, cargo gets hooked by key command when player landed close enough the selected cargo.

The cargo selection can be cancelled by the command menu: [\] -> [F6] -> [F1] . After this, by using [\] -> [F6] all the cargos within a 2,000m radius will again be available.

To help the player to determine the required flight direction towards the cargo and also the helicopter location above the cargo, a cargo display can be activated [LShift+LCtrl+C], which is a virtual camera directed downwards perpendicular to the horizon. The camera does not take into account the roll and pitch deflections. It considers the heading alterations only. Also it has a marker of azimuth cargo position (see [Figure 11.6](#)).

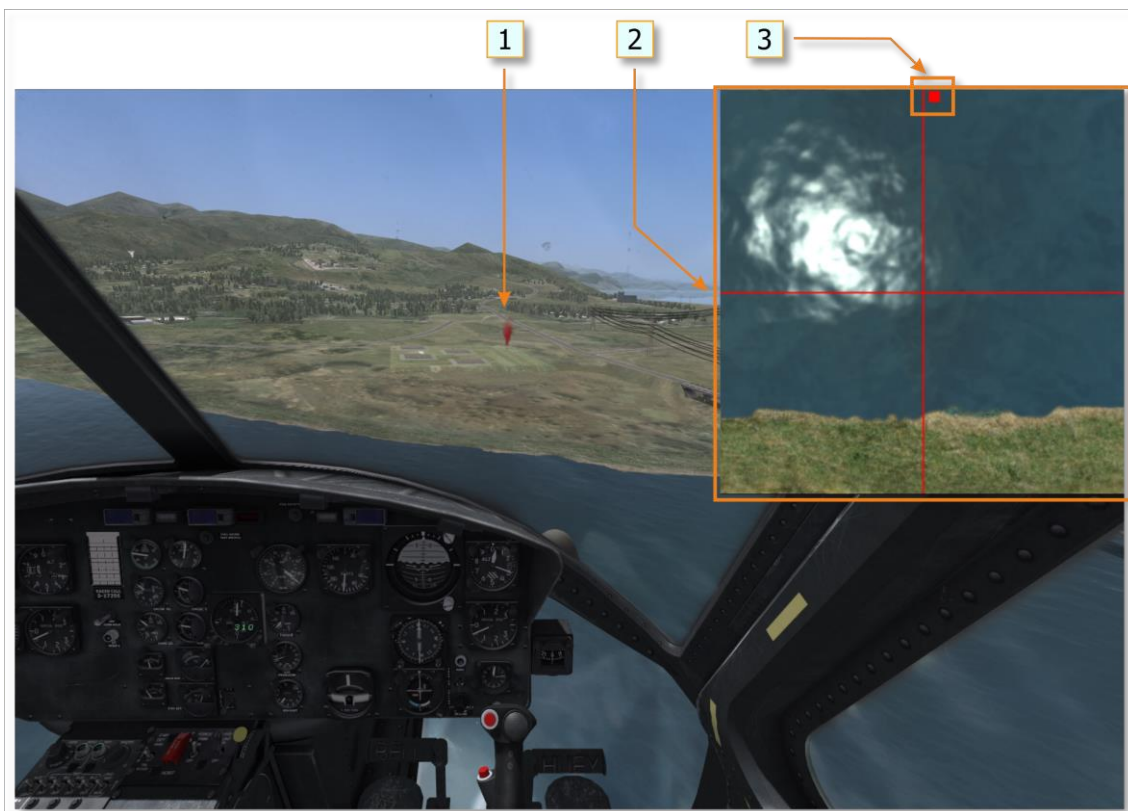

Figure 11.6. Display of Cargo Position.

1. Smoke marker
2. Cargo position display
3. Marker of cargo position

To lift off cargo from the surface the helicopters hovering altitude should be at least 8.96m (radioaltimeter indications must be at least 30 ft).

AUTOMATIC ATTACHMENT OF CARGO (CARGO HOOKED) actuates if the actuates if the player meets several conditions, which take into account the rope suspension length (7m or 23ft), the accuracy of the hovering position and the interval necessary for a virtual hookup man to hook the load. Therefore, in order to carry out an automatic attachment of cargo it is necessary to hover within a

specified time lapse in a certain area above the cargo with the deviations from the center no more than:

- (1) relative to the longitudinal axis – 2m (6ft);
- (2) relative to the transversal axis – 2m (6ft);
- (3) relative to the vertical axis (the range of allowable hoverheights above the cargo is from 2.5m to 7m (8..23ft))

and be within the attachment area no less than 5 sec.

While within the attachment area (provided that all the conditions are met) the message HOVERING ABOVE CARGO will appear (see [Figure 11.7](#)).



Figure 11.7. Conditions for Automatic Attachment of Load at Hovering Method (1 of 2).



Figure 11.8. Conditions for Automatic Attachment of Load at Hovering Method (2 of 2).

In case you are out of the attachment area, the message BEYOND ZONE OF HOVERING will appear. Once the cargo is automatically attached, the message CARGO HOOKED will appear.

While hovering above the cargo using the camera it is recommended to use it only by peripheral vision with your attention being focused on the surface before the helicopter in a sweeping glance so as to maintain the hovering position more accurately from displacements relative to the longitudinal and transversal axes.

MANUAL ATTACHMENT OF CARGO (CARGO HOOKED) is carried out by player's command [RShift+RCtrl+L] after landing near the cargo (the distance from the helicopter center is no more than 5m or 16ft), see [Figure 11.9](#).



Figure 11.9. Cargo Hooked (Landing Method).

As a result of attaching cargo a rope suspension appears. The cargo selection can be cancelled by the command menu: [\] -> [F6] -> [F1] . After this, by using [\] -> [F6] all the cargos within a 2,000m radius will again be available.

Take off with a sling load

Upon receiving the message CARGO HOOKED, take off vertically with the sling load. Perform the vertical climb up to the height so as the cargo is higher no less than 5m (15ft) than hazards in the runway heading. After the climb without hover locking accelerate to 60 KNOTS and continue the climb to the specified value.

Flight to the unhooked area

After the climb put the helicopter over at the speed of 60..100KNOTS. During the flight when the cargo swing occurs, damp out oscillations:

- when the roll oscillations occurs – make a small roll movement in the same direction where the cargo is moving or reduce a little the collective pitch at the moment when the cargo is close to one of the end points;
- when the pitch oscillations occurs – reduce a little the collective pitch at the moment when the cargo is close to one of the end points.

Approach to the area of the load detachment, detachment of load (cargo unhook)

You should approach the area of the load detachment much smoother than during the usual flight. Mark visually the hovering position and reference points (2..3) at the distance of 10..30m (30..100ft) from the hovering position to make it easier to keep to the hovering position. These reference points must be seen from the cockpit during the hovering. It is recommended to keep in sight the chosen reference points by sweeping motion of the eyes so as you could timely correct even the initial helicopter displacement tendencies. It is necessary to perform *SHORT TWOFOLD MOTIONS BY THE CYCLIC CONTROL STICK* (amplitude is 0.5..1cm, motion rate is 1.5..2Hz) for more precise piloting.

For more comfortable load detachment you can activate the load automatic detachment function [RShift+RCtrl+K]. This will provide for an automatic detachment of the cargo when it touches down the surface. The automatic detachment is accompanied by the message AUTOUNHOOK ACTIVATION.

Likewise, the cargo can be unhooked after landing near the cargo (the same key commands).

11.2. Helicopter assault (airlift delivery)

WIP

11.3. Multiplayer missions with multi-crew

11.3.1. Create a multiplayer mission

From the main menu, create a new multiplayer mission:

1. Choose "Mission Editor" from the main menu.

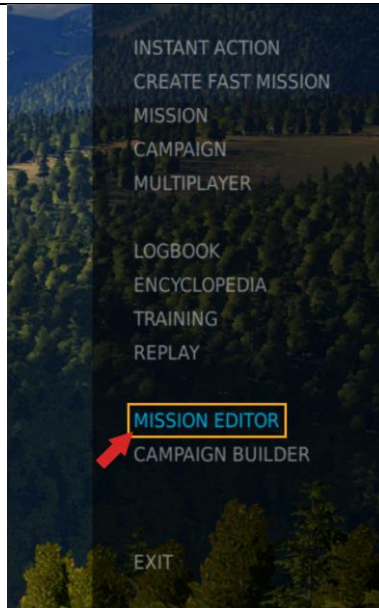

2. Choose "create new mission" or File > New.

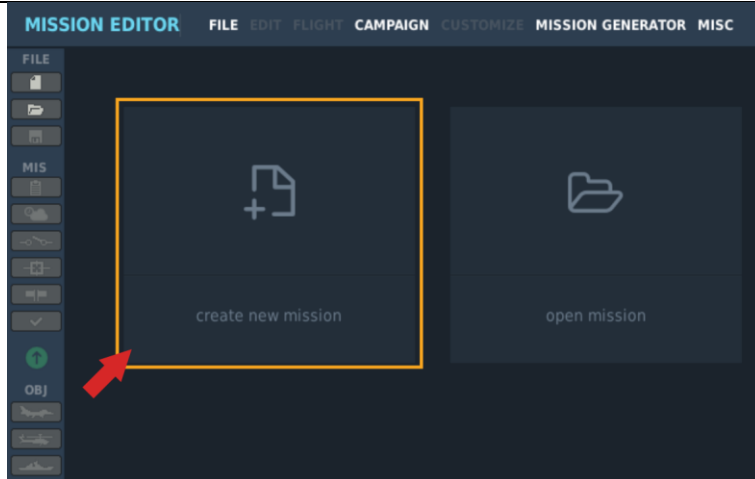

3. You will now be able to choose the theater and coalitions.

This window allows you to define a map and what countries (factions) will be assigned to one of the two sides. Unassigned countries will not take part in the mission. In the left side window all unassigned factions are listed; in the top right window the RED side factions are listed; and in the lower right window all BLUE side factions are listed. To move a faction,



left click on the desired faction and then press either the left or right arrow button to move it between the unassigned window and a side window or press the up and down arrows to move the faction to the other side directly. You can just click "OK" if you don't need to customize these settings.

4. Add a helicopter group to your mission. Click the "Add or modify helicopter group" button.

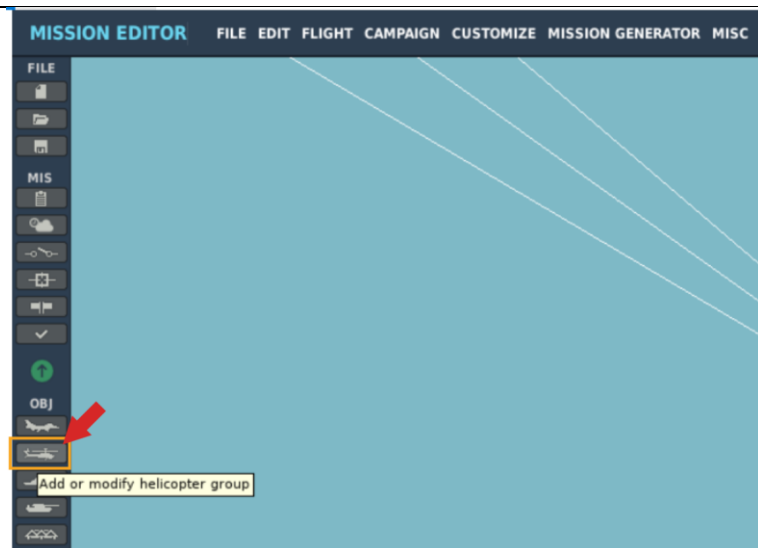

5. Specify a location where your new helicopter group will start.
5.1. Starting on an airfield or a FARP
5.1.1. Click at the location of the airfield or FARP on the map.



5.1.2. Set the properties of your new helicopter group:
 Change the group Type to "UH-1H" (see #1 and #2).
 Give the group a name if you wish.
 Ensure the group's Country is correct.
 Changing the group's Task will automatically select its payload.
 Changing the second Unit number will alter the number of airframes in the group.
 Change the Skill to either Player or Client for a human-controlled group, or set the AI skill level.
 Set any other properties you need.

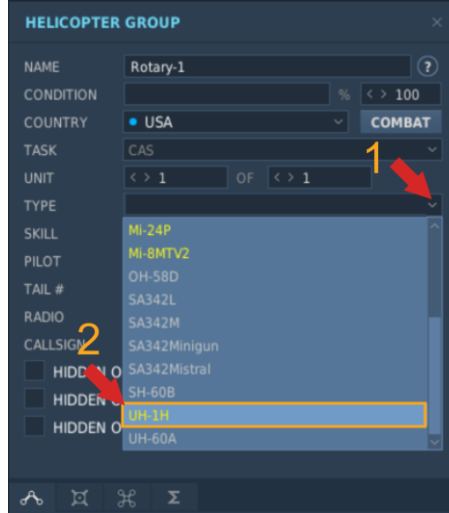

5.1.3. Choose one of the "Takeoff" options for your first waypoint; otherwise, your helicopter group will start in the air.

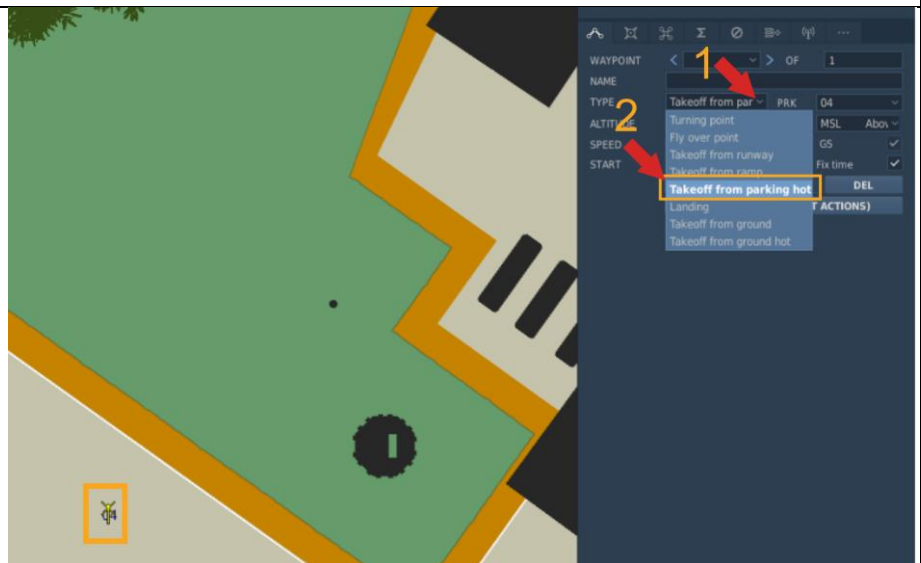

5.2. Starting on a carrier
 5.2.1. Click the "Add or modify ship group" button.



5.2.2. Click in the sea where you want the carrier to start.
 5.2.3. Clicking the "Show Models" button (#2) will depict the carrier as a top-down 3D model.

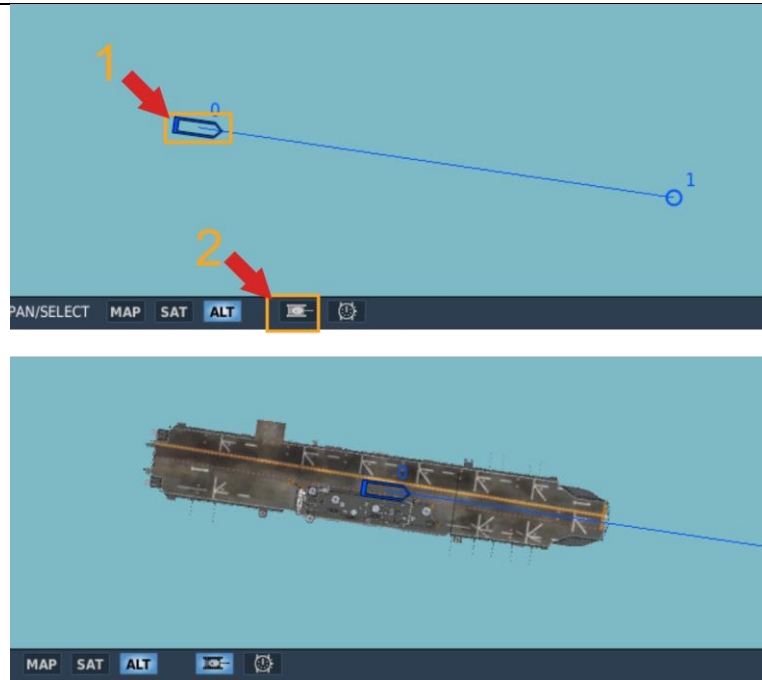

5.2.4. Click the "Add or modify helicopter group" button, then click near the carrier.
 Change the Type of the first waypoint to one of the "Takeoff" options (#2 and #3), at which point the helicopter icon will snap to the location of the carrier (#4).

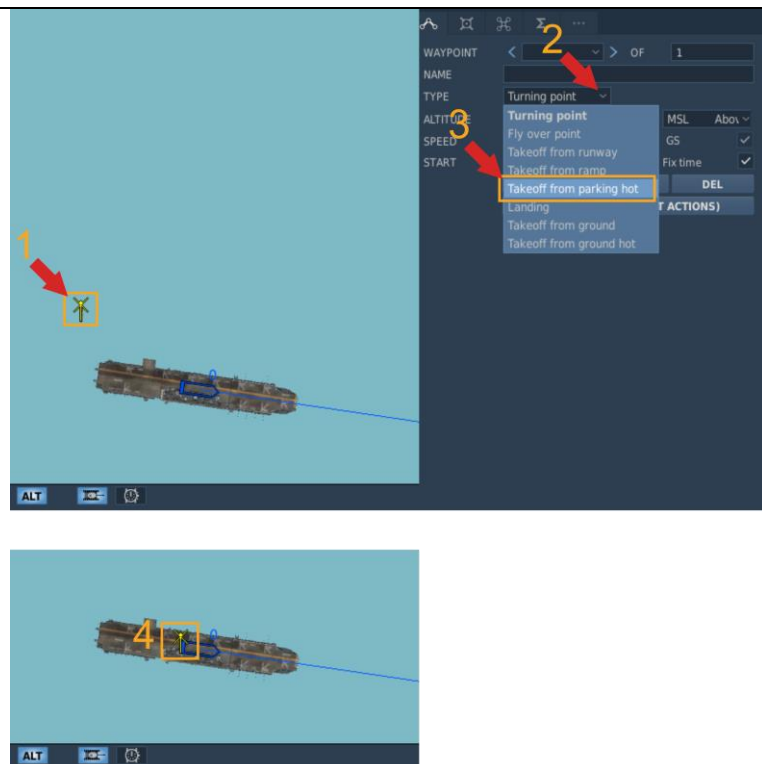

6. Set the payload. Click the Payload tab (#1) and right-click on each station to change the loadout (#2).

Note: For multi-crew gunner positions, you must load the M134D or M60 on stations 3 and/or 4.

In addition, you can use this tab to set the amount of internal fuel (INTERNAL FUEL slider), the amount of chaff and flares, and the rope length (for sling-load operations).

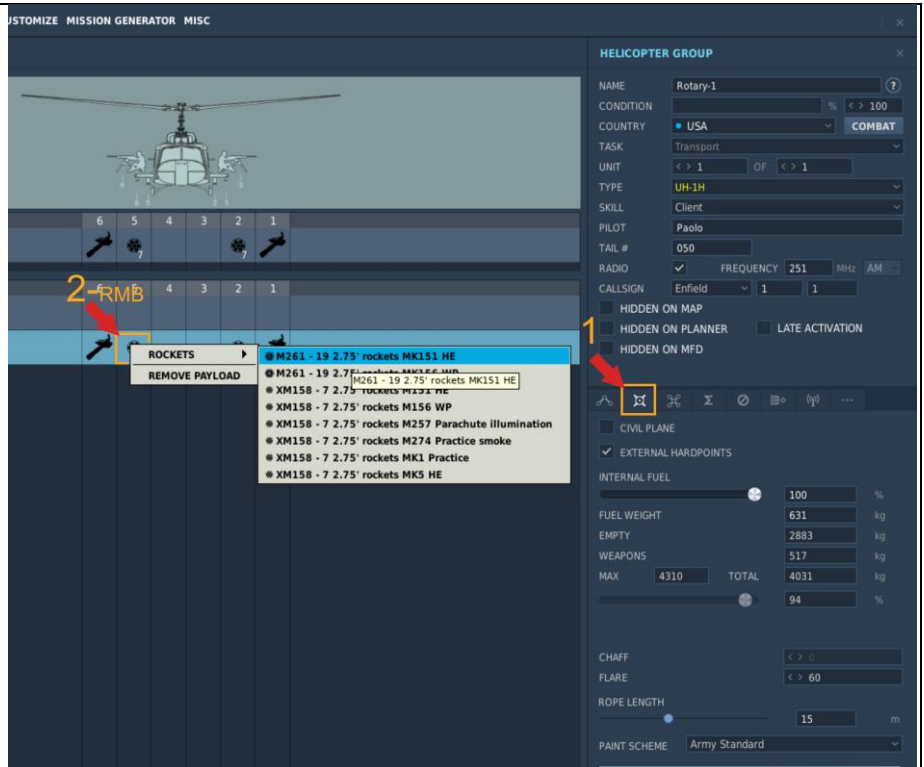

7. Save the mission by choosing File > Save As.

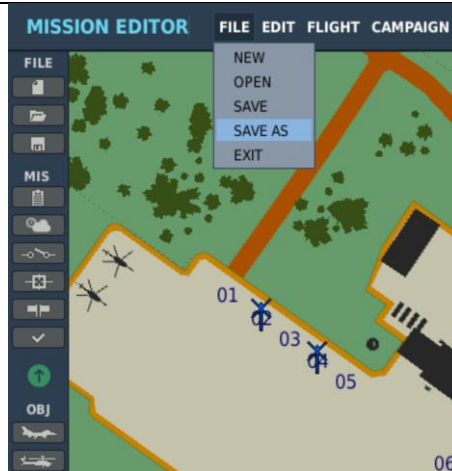

For multiplayer missions with multiple crewable helicopters, it is necessary to set the Skill level of all crewable helicopters to "Client" (not "Player").

11.3.2. Start a multiplayer session

<p>1. Hosting a multiplayer session 1.1. From the main menu, choose "Multiplayer".</p>	
<p>1.2. Click "New Server".</p>	
<p>1.3. Configure the server: Change the server name (#1). Set a server password if necessary (#2). Add one or more missions mission (#3). Clicking this opens the Mission Explorer window. Select a mission (#4). Start the server (#5).</p>	

1.4. At the "Select role" screen, choose the helicopter and seat you wish to occupy (#1), then click "Briefing" (#2).

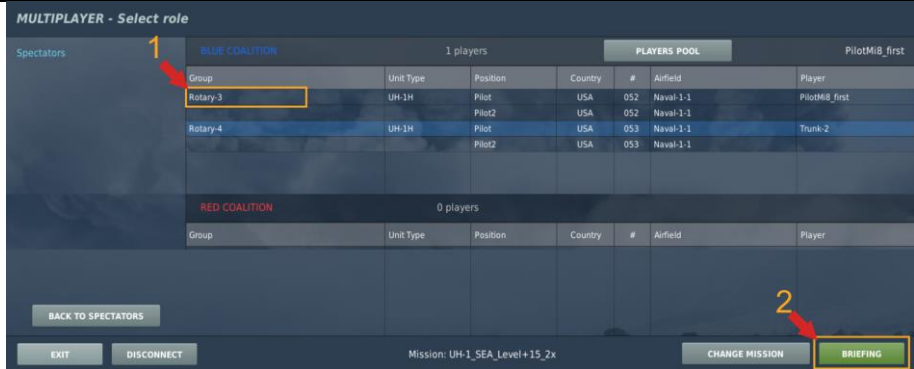

1.5. Once you are ready, click "Fly".



1.6. You will appear in your selected helicopter, at your chosen seat.



2. Joining a multiplayer session
 2.1. Locate the host's server (#1) and choose "Join" (#2).

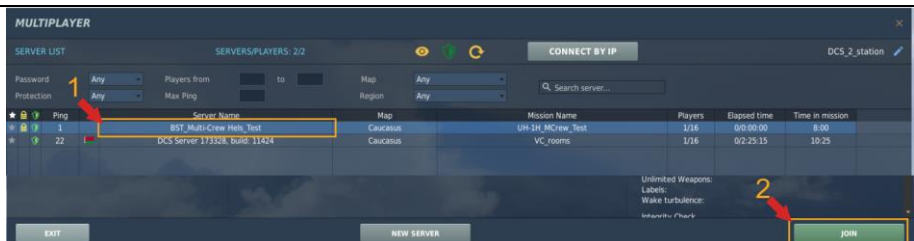

<p>2.2. Enter the password chosen by the host, if required.</p>																													
<p>2.3. Join as pilot: 2.3.1. Select the "Pilot" slot for the helicopter you wish to fly, then click "Briefing".</p>	<table border="1"> <thead> <tr> <th>Group</th> <th>Unit Type</th> <th>Position</th> <th>Country</th> <th>#</th> <th>Airfield</th> <th>Player</th> </tr> </thead> <tbody> <tr> <td>Rotary-3</td> <td>UH-1H</td> <td>Pilot</td> <td>USA</td> <td>052</td> <td>Naval-1-1</td> <td>PilotM8_first</td> </tr> <tr> <td>Rotary-4</td> <td>UH-1H</td> <td>Pilot</td> <td>USA</td> <td>053</td> <td>Naval-1-1</td> <td>Trunk-2</td> </tr> <tr> <td>Rotary-4</td> <td>UH-1H</td> <td>Pilot2</td> <td>USA</td> <td>053</td> <td>Naval-1-1</td> <td></td> </tr> </tbody> </table>	Group	Unit Type	Position	Country	#	Airfield	Player	Rotary-3	UH-1H	Pilot	USA	052	Naval-1-1	PilotM8_first	Rotary-4	UH-1H	Pilot	USA	053	Naval-1-1	Trunk-2	Rotary-4	UH-1H	Pilot2	USA	053	Naval-1-1	
Group	Unit Type	Position	Country	#	Airfield	Player																							
Rotary-3	UH-1H	Pilot	USA	052	Naval-1-1	PilotM8_first																							
Rotary-4	UH-1H	Pilot	USA	053	Naval-1-1	Trunk-2																							
Rotary-4	UH-1H	Pilot2	USA	053	Naval-1-1																								
<p>2.4. Join as copilot or gunner: 2.4.1. Select the "Pilot2" slot for the helicopter you wish to crew, then click "Briefing".</p> <p>Note: The "Player" column indicates which players have occupied which roles.</p>	<table border="1"> <thead> <tr> <th>Group</th> <th>Unit Type</th> <th>Position</th> <th>Country</th> <th>#</th> <th>Airfield</th> <th>Player</th> </tr> </thead> <tbody> <tr> <td>HelGroup-1</td> <td>UH-1H</td> <td>Pilot</td> <td>USA</td> <td>050</td> <td>Batumi</td> <td>DCS_1_station</td> </tr> <tr> <td>HelGroup-1</td> <td>UH-1H</td> <td>Pilot2</td> <td>USA</td> <td>050</td> <td>Batumi</td> <td>DCS_2_station</td> </tr> </tbody> </table>	Group	Unit Type	Position	Country	#	Airfield	Player	HelGroup-1	UH-1H	Pilot	USA	050	Batumi	DCS_1_station	HelGroup-1	UH-1H	Pilot2	USA	050	Batumi	DCS_2_station							
Group	Unit Type	Position	Country	#	Airfield	Player																							
HelGroup-1	UH-1H	Pilot	USA	050	Batumi	DCS_1_station																							
HelGroup-1	UH-1H	Pilot2	USA	050	Batumi	DCS_2_station																							
<p>2.5. If the "Pilot" slot for that helicopter is occupied by another player: The copilot will see a "Pending request" dialog. The pilot will have the opportunity to accept or deny the multicrew request.</p>																													

<p>2.6. If the pilot rejects the request, the copilot will see a "Denied" message.</p>		
<p>2.7. If the pilot approves the request, the copilot will see an "Access granted" message.</p>		
<p>2.8. When ready, choose "Briefing".</p>		
<p>2.9. When ready, choose "Fly".</p>		

2.10. You will join in the copilot position, and within a few seconds, see a message confirming that you joined the crew.



2.11. The pilot will see a message confirming that you joined the crew.



11.3.3. Request or transfer control

In the example below, the pilot is named "DCS_1_Station" and the copilot is named "DCS_2_Station".

1. If the copilot wishes to request control, they can press the [C] key. A message will be sent to the pilot.



2. The pilot will receive a message, and can then allow or deny the request.



3. If the pilot rejects the request, the copilot will see a message indicating that the pilot still has control.



4. If the pilot approves the request, the copilot will see a message indicating they have control.



5. If the pilot approves the request, they will see a message confirming that the copilot took control from them.



6. At any time, the pilot can retake control from the copilot by pressing **[C]**. The copilot is not asked to approve this request. In this case:

6.1. The pilot will see a message confirming that they have control again.



6.2. The copilot will see a message indicating that the pilot has retaken control.



The pilot who does not have control may assume a gunner position at any time, if the helicopter was loaded with crewed guns. To do so, press the **[3]** (Left Gunner's Crew Station) or **[4]** key (Right Gunner's Crew Station).

Note: This feature is a work in progress. Currently only two players can crew a helicopter. In the future, it will be possible for up to 4 players to man the pilot, copilot, and both gunner positions.



12

EMERGENCY
PROCEDURES

12. EMERGENCY PROCEDURES

12.1.1. Definition of Emergency Terms

For the purpose of standardization the following definitions shall apply:

- a) The term LAND AS SOON AS POSSIBLE is defined as executing a landing to the nearest suitable landing area without delay. The primary consideration is to assure the survival of occupants.
- b) The term LAND AS SOON AS PRACTICABLE is defined as executing a landing to a suitable airfield, heliport, or other landing area as the situation dictates.
- c) The term AUTOROTATE is defined as adjusting the flight controls as necessary to establish an autorotational descent (See [3.1.13](#) and [9.7](#)).
 - (1) COLLECTIVE ADJUST as required to maintain rotor RPM.
 - (2) PEDALS ADJUST as required.
 - (3) THROTTLE ADJUST as required.
 - (4) AIRSPEED ADJUST as required.
- d) The term EMER SHUTDOWN is defined as engine stoppage without delay.
 - (1) THROTTLE – OFF.
 - (2) FUEL switches – OFF.
 - (3) BAT switch – OFF.

CAUTION. The maximum engine torque available for any ambient condition will be reduced by 6 to 8 PSI when the GOV AUTO/EMER switch is placed in the EMER position.

- e) The term EMER GOV OPNS is defined as manual control of the engine RPM with the GOV AUTO/EMER switch in the EMER position. Because automatic acceleration, deceleration, and overspeed control are not provided with the GOV switch in the EMER position, throttle and collective coordinated control movements must be smooth to prevent compressor stall, overspeed, overtemperature, or engine failure.
 - (1) GOV switch – EMER.
 - (2) Throttle – adjust as necessary to control RPM.
 - (3) Land as soon as possible.

12.1.2. Engine Malfunction – Partial or Complete Power Loss

A. Indications

The indications of an engine malfunction, either a partial or a complete power loss, are:

- a) change in engine and transmission noise;
- b) left yaw (up to 10..15°);
- c) drop in engine rpm, drop in rotor rpm;
- d) low rpm audio alarm, illumination of the rpm warning light;
- e) loss of altitude.

B. Flight characteristics

- a) Control response with an engine inoperable is similar to a descent with power.
- b) Airspeed above the minimum rate of descent values will result in greater rates of descent and should only be used as necessary to extend glide distance (see [9.7](#)).
- c) Airspeeds below minimum rate of descent airspeeds will increase rate of descent and decrease glide distance.
- d) Should the engine malfunction during a left bank maneuver, right cyclic input to level the aircraft must be made simultaneously with collective pitch adjustment. If the collective pitch is decreased without a corresponding right cyclic input, the helicopter will pitch down and the roll rate will increase rapidly, resulting in a significant loss of altitude.

WARNING. Do not close the throttle. Do not respond to the rpm audio and/or warning light illumination without first confirming engine malfunction by one or more of the other indications. Normal indications signify the engine is functioning properly and that there is a tachometer generator failure or an open circuit to the warning system, rather than an actual engine malfunction.

C. Partial power condition

Under partial power conditions, the engine may operate relatively smoothly at reduced power or it may operate erratically with intermittent surges of power. In instances where a power loss is experienced without accompanying power surging, the helicopter may sometimes be flown at reduced power to a favorable landing area. Under these conditions, the pilot should always be prepared for a complete power loss. In the event a partial power condition is accompanied by erratic engine operation or power surging, and flight is to be continued, the GOV switch may be moved to the EMER position and throttle adjusted in an attempt to correct the surging condition. If flight is not possible, close the throttle completely and complete an autorotational landing.

D. Complete power loss

- a) Under a complete power loss condition, delay in recognition of the malfunction, improper technique or excessive maneuvering to reach a suitable landing area reduces the probability of a safe autorotational landing. Flight conducted within the caution area of the height-velocity chart exposes the helicopter to a high probability of damage despite the best efforts of the pilot:

- (1) in altitude (skid height above ground) 10..430 feet and velocity about 0 knots (hovering);
 - (2) in altitude (skid height above ground) about 100 feet and velocity below 50 knots;
 - (3) in altitude (skid height above ground) below 15 feet and velocity above 60 knots;
- b) From conditions of low airspeed and low altitude, the deceleration capability is limited, and caution should be used to avoid striking the ground with the tail rotor. Initial collective reduction will vary after an engine malfunction dependent upon the altitude and airspeed at the time of the occurrence. For example, collective pitch may not need to be decreased when an engine failure occurs at a hover in ground effect; whereas, during cruise flight conditions, altitude and airspeed are sufficient for a significant reduction in collective pitch, thereby, allowing rotor rpm to be maintained in the safe operating range during autorotational descent. At high gross weights, the rotor may tend to overspeed and require collective pitch application to maintain the rpm below the upper limit. Collective pitch should never be applied to reduce rpm below normal limits for extending glide distance because of the reduction in rpm available for use during autorotational landing.

12.1.3. Engine Restart – During Flight

After an engine failure in flight, resulting from a malfunction of fuel control unit, an engine start may be attempted. Because the exact cause of engine failure cannot be determined in flight, the decision to attempt the start will depend on the altitude and time available, rate of descent, potential landing areas, and crew assistance available. Under ideal conditions approximately one minute is required to regain powered flight from time the attempt start is begun. If the decision is made to attempt an in-flight start:

1. Throttle – OFF.
2. STARTER GEN switch – START.
3. FUEL switches – ON.
4. GOV switch – EMER.
5. Attempt start.
 - (1) Starter switch – Press.
 - (2) Throttle – Open slowly to 6400 to 6600 rpm as N1 passes through 8%. Control rate of throttle application as necessary to prevent exceeding EGT limits.
 - (3) Starter Switch – Release as N1 passes through 40%. After the engine is started and powered flight is reestablished, continue with manual control. Return the STARTER GEN switch to STANDBY.

6. Land as soon as possible.

12.1.4. Engine Overspeed

Engine overspeed will be indicated by a right yaw, rapid increase in both rotor and engine rpm, rpm warning light illuminated, and an increase in engine noise. An engine overspeed may be caused by a malfunctioning N2 governor or fuel control. Although the initial indications of high N2 rpm and rotor rpm are the same in each case, actions that must be taken to control rpm are distinctly different. If the N2 governor malfunctions, throttle reduction will result in a corresponding decrease in N2 rpm. In the event of a fuel control malfunction, throttle reduction will have no effect on N2 rpm. If an overspeed is experienced:

- a) Collective – Increase to load the rotor in an attempt to maintain rpm below the maximum operating limit.
- b) Throttle – Reduce until normal operating rpm is attained. Continue with manual throttle control. If reduction of throttle does not reduce rpm as required:

WARNING. Land even if manual throttle corrects the overspeed since there is a chance of an impending engine failure due to the debris generated by the initial N2 failure.

- c) EMER GOV OPNS

12.1.5. Transmission Oil – Hot or Low Pressure

If the transmission oil temperature XMSN OIL HOT caution light illuminates, limits on the transmission oil temperature gauge are exceeded; XMSN OIL PRESS caution light illuminates, or limits on the transmission oil pressure gauge are exceeded (low or high):

- a) Land as soon as possible.
- b) EMER SHUTDOWN – After landing.

WARNING. Do not close throttle during this emergency procedure. Descent and landing must be made with normal engine operating RPM.

Should transmission oil pressure drop to zero psi, a valid cross reference cannot be made with the oil temperature indicators. The oil temperature gauge and transmission oil hot warning lights are dependent on fluid for valid indications.

12.1.6. Tail Rotor Malfunctions

Because of the many different malfunctions that can occur, it is not possible to provide a solution for every emergency. The success in coping with the emergency depends on quick analysis of the condition.

12.1.7. Complete Loss of Tail Rotor Thrust

This situation involves a break in the drive system, such as a severed driveshaft, wherein the tail rotor stops turning or tail rotor controls fail with zero thrust.

A. Indications.

a) In-Flight.

- (1) Pedal input has no effect on helicopter trim.
- (2) Nose of the helicopter turns to the right (left sideslip).
- (3) Roll of fuselage along the longitudinal axis.
- (4) Nose down tucking will also be present.

WARNING. At airspeeds below 30 to 40 knots, the sideslip may become uncontrollable, and the helicopter will begin to revolve on the vertical axis (right or left depending on power, gross weight, etc.).

b) Hover.

Helicopter heading cannot be controlled with pedals.

B. Procedures.

a) In-Flight.

- (1) If aircraft is uncontrollable.
- (2) If safe landing area is not immediately available and powered flight is possible, continue flight to a suitable landing area at or above minimum rate of descent airspeed. Degree of roll and sideslip may be varied by varying throttle and/or collective.

CAUTION. The flare and the abrupt use of collective will cause the nose to rotate left, but do not correct with throttle. Although application of throttle will result in rotation to the right, addition of power is a very strong response measure and is too sensitive for the pilot to manage properly at this time. DO NOT ADD POWER AT THIS TIME. Slight rotation at time of impact at zero ground speed should not cause any real problem.

- (3) If landing area is suitable, touchdown at a ground speed above effective translational lift utilizing throttle as necessary to maintain directional control.
- (4) If landing area is not suitable for a run-on landing, a minimum ground run autorotation must be performed: enter autorotation descent (throttle off), start to decelerate at about 75 feet altitude so that forward ground speed is at a minimum when the helicopter reaches 10 to 20 feet, execute the touchdown with a rapid collective pull just prior to touchdown in a level attitude with minimum ground speed.

b) Hover.

AUTOROTATE.

12.1.8. Loss of Tail Rotor Effectiveness

This is a situation involving a loss of effective tail rotor thrust without a break in the drive system. The condition is most likely to occur at a hover or low airspeed as a result of one or more of the following.

- a) Out-of-ground effect hover.
- b) High pressure altitude/high temperature.
- c) Adverse wind conditions.
- d) Engine/rotor rpm below 6600/324.
- e) Improperly rigged tail rotor.
- f) High gross weight.

A. Indications

The first indication of this condition will be a slow starting right turn of the nose of the helicopter which cannot be stopped with full left pedal application. This turn rate will gradually increase until it becomes uncontrollable or, depending upon conditions, the aircraft aligns itself with the wind.

B. Procedures

Lower collective to regain control and as recovery is effected adjust controls for normal flight.

12.1.9. Main Driveshaft Failure

A failure of the main driveshaft will be indicated by a left yaw (this is caused by the drop in torque applied to the main rotor), increase in engine rpm, decrease in rotor rpm, low rpm audio alarm (unmodified system), and illumination of the rpm warning light. This condition will result in complete loss of power to the rotor and a possible engine overspeed. If a failure occurs:

- a) Autorotate.
- b) EMER SHUTDOWN.

12.1.10. Fire During Flight

If the fire light illuminates and/or fire is observed during flight, prevailing circumstances (such as VFR, IMC, night, altitude, and landing areas available), must be considered in order to determine whether to execute a power-on, or a power-off landing.

- a) Power-On.
 - (1) Land as soon as possible.
 - (2) EMER SHUTDOWN after landing.
- b) Power-Off.
 - (1) Autorotate.
 - (2) EMER SHUTDOWN.

12.1.11. Hydraulic Power Failure

Hydraulic power failure will be evident when the force required for control movement increases; a moderate feedback in the controls when moved is felt, and/or the HYD PRESSURE caution light illuminates. Control movements will result in normal helicopter response. In the event of hydraulic power failure:

- a) Airspeed – Adjust as necessary to attain the most comfortable level of control movements.
- b) HYD CONT circuit breaker – Out.
- c) If hydraulic power is not restored:
- d) HYD CONT circuit breaker – In.
- e) HYD CONT switch – OFF.
- f) Land as soon as practicable at an area that will permit a run-on landing with power. Maintain airspeed at or above effective translational lift until touchdown.

12.1.12. Control Stiffness

A failure within the irreversible valve may cause extreme stiffness in the collective or two of the four cyclic control quadrants. If the failure is in one of the two cyclic irreversible valves, caution is necessary to avoid over controlling between the failed and operational quadrants.

- a) HYD CONT switch – OFF then ON.

Check for restoration of normal flight control movements.

Repeat as necessary.

If control response is not restored:

- b) HYD CONT switch – OFF if normal operation is not restored.
- c) Land as soon as practicable at an area that will permit a run-on landing with power. Maintain airspeed at or above effective translational lift until touchdown.

12.1.13. Flight Control Servo Hardover

- a) Cyclic hardover is caused by a sequencing valve failure within the irreversible valve on either or both cyclic servos. Cyclic servo hardover will cause the cyclic to move full right forward, full left rear, full left forward, or full right rear.
- b) Collective hardover is caused by a sequencing valve failure within the irreversible valve on the collective servo. The collective will move to the full up or full down position.
- c) A failure of any flight control servo may render the helicopter uncontrollable unless the following action is taken.
 - (1) HYD CONT switch – Select opposite position.

- (2) LAND AS SOON AS POSSIBLE at an area that will permit a run-on landing with power. Maintain airspeed at or above effective translational lift at touchdown.

12.1.14. Flight Control/Main Rotor System Malfunctions

- a) Failure of components within the flight control system may be indicated through varying degrees of feedback, binding, resistance, or sloppiness. These malfunctions are normally in isolated controls, i.e. cyclic, cyclic/collective, or anti-torque. These conditions should not be mistaken for hydraulic power failure.
- b) Imminent failure of main rotor components may be indicated by a sudden increase in main rotor vibration and/or unusual noise. Severe changes in lift characteristics and/or balance condition can occur due to blade strikes, skin separation, shift or loss of balance weights or other material. Malfunctions may result in severe main rotor flapping. In the event of a main rotor system malfunction, proceed as follows:

WARNING. Danger exists that the main rotor system could collapse or separate from the aircraft after landing. A decision must be made whether occupant egress occurs before or after the rotor has stopped.

- (1) Land as soon as possible.
- (2) EMER SHUTDOWN after landing.

12.1.15. Mast Bumping

If mast bumping occurs:

- a) Reduce severity of maneuver.
- b) Land as soon as possible.

12.1.16. Electrical System

12.1.17. Main Generator Malfunction

A malfunction of the main generator will be indicated by zero indication of the Main Generator Loadmeter and DC GENERATOR caution light illumination. An attempt may be made to put the generator back on line as follows:

- a) GEN and BUS RESET circuit breaker – IN.
- b) MAIN GEN switch – RESET then ON. Do not hold the switch in the RESET POSITION. If the main generator is not restored or if it goes off again:
- c) MAIN GEN switch – OFF.

NOTE. Check that the standby generator loadmeter is indicating a load. Flight may be continued using the standby generator.

12.1.18. Landing and Ditching

12.1.19. Landing in Trees

A landing in trees should be made when no other landing area is available. Select a landing area containing the least number of trees of minimum height. Decelerate to a zero ground speed at tree-top level and descend into the trees vertically, applying collective pitch as necessary for minimum rate of descent. Prior to the main rotor blades entering the trees, ensure throttle is OFF and apply all of the remaining collective pitch.

12.1.20. Ditching – Power On

If it becomes necessary to ditch the helicopter, accomplish an approach to an approximate 3-foot hover above the water and proceed as follows:

1. Cockpit doors – Jettison at a hover.
2. Cabin doors – Open.
3. Crew (except pilot) and passengers – Exit.
4. Hover a safe distance away from personnel.
5. Throttle – Off and autorotate. Apply full collective pitch prior to the main rotor blades entering the water. Maintain a level attitude as the helicopter sinks and until it begins to roll, then apply cyclic in direction of the roll.
6. Pilot – Exit when the main rotor is stopped.

12.1.21. Ditching – Power Off

If ditching is imminent, accomplish engine malfunction emergency procedures. Decelerate to zero forward speed as the helicopter nears the water. Apply all of the collective pitch as the helicopter enters the water. Maintain a level attitude as the helicopter sinks and until it begins to roll, then apply cyclic in the direction of the roll. Exit when the main rotor is stopped.

1. Cockpit doors – Jettison prior to entering water.
2. Cabin Doors – Open prior to entering water.
3. Exit when main rotor has stopped.



13 KEY COMMAND LIST

13. KEY COMMAND LIST

Object\Procedure	Key Command
ADF Set Control panel	
ADF BFO Switch	LAlt + LCtrl + 0
ADF Band 190-400 kHz	LAlt + LCtrl + 6
ADF Band 400-850 kHz	LAlt + LCtrl + 7
ADF Band 850-1750 kHz	LAlt + LCtrl + 8
ADF Band Select (rotary)	LAlt + LCtrl + 5
ADF Frequency Decrease	LAlt + LCtrl + [
ADF Frequency Increase	LAlt + LCtrl +]
ADF Gain Decrease	LAlt + LCtrl + -
ADF Gain Increase	LAlt + LCtrl + =
ADF Loop Left High	LAlt + LCtrl + Z
ADF Loop Left Low	LAlt + LCtrl + X
ADF Loop Right High	LAlt + LCtrl + V
ADF Loop Right Low	LAlt + LCtrl + C
ADF Mode ADF	LAlt + LCtrl + 2
ADF Mode ANT	LAlt + LCtrl + 3
ADF Mode LOOP	LAlt + LCtrl + 4
ADF Mode OFF	LAlt + LCtrl + 1
ADF Mode Select (rotary)	LAlt + LCtrl + '
Armament System	
Armament Off/Safe/Armed Down	RShift + [
Armament Off/Safe/Armed Up	RShift +]
Armament Selector Down	RAlt + [
Armament Selector Up	RAlt +]
Gun Selector Switch Down	RAlt + RCtrl + [
Gun Selector Switch Up	RAlt + RCtrl +]
Jettison	J
Jettison Cover	LAlt + J
Open/Close Left Gunner Door	LAlt + 3
Open/Close Right Gunner Door	LAlt + 4
Rocket Pair Decrease	RCtrl + [
Rocket Pair Increase	RCtrl +]
Rocket reset	LCtrl + R
CHEAT	
Active Pause	LShift + LWin + Pause
Auto execute full start procedure	LWin + Home
Auto execute full stop procedure	LWin + End
AutoPilot	LWin + A
Autopilot ATTITUDE HOLD	LAlt + LShift + A
AutoPilot LEVEL FLIGHT	LCtrl + A
Autopilot ORBIT	LAlt + A
Explosion	LCtrl + LShift + X

Weapon Hints On/Off	LCtrl + LShift + H
Circuit Breaker Panel	
CB ARC-102 HF Static INVTR	
CB Anticollision light	
CB Cabin heater (Air valve)	
CB Cabin heater (Outlet valve)	
CB Cargo hook release	
CB Caution lights	
CB Cockpit lights	
CB Console lights	
CB Dome lights	
CB EXT Store jettison	
CB Engine anti-ice	
CB FM 2 Radio	
CB FM Radio	
CB FORCE Trim	
CB Fire detector	
CB Fuel TRANS	
CB Fuel valves	
CB Fuselage lights	
CB Generator & Bus Reset	
CB Governor Control	
CB HF ANT COUPLR	
CB HF ARC-102	
CB HYD Control	
CB Heated blanket 1	
CB Heated blanket 2	
CB IDLE Stor relay	
CB IFF APX 1	
CB IFF APX 2	
CB INST Panel lights	
CB INST SEC lights	
CB Ignition system	
CB Intercom CPLT	
CB Intercom PLT	
CB Inverter CTRL CB	
CB KY-20 voice security	
CB LF Nav. (ARN-83)	
CB LH fuel boost pump	
CB Landing & Search light control	
CB Landing light power	
CB Main inverter PWR	
CB Marker beacon	
CB Navigation lights	

CB Pitot tube	
CB Prox. warn.	
CB RH fuel boost pump	
CB RPM Warning system	
CB Rescue hoist CTL	
CB Rescue hoist PWR	
CB Rescue hoist cable cutter	
CB STBY Generator Field	
CB Search light power	
CB Spare inverter PWR	
CB Starter Relay	
CB TEMP indicator	
CB Turn & Slip indicator	
CB UHF Radio	
CB VHF AM Radio	
CB VHF Nav. (ARN-82)	
CB Voltmeter Non Ess Bus	
CB Wind wiper CPLT	
CB Wind wiper PLT	
Radar Altimeter Power	RShift + R
External Cargo	
External Cargo Autounhook	RCtrl + RShift + K
External Cargo Camera On/Off	LCtrl + LShift + C
External Cargo Hook/Unhook	RCtrl + RShift + L
Flexible Sight	
Flexible Sight Backup Lamp	RAIt + RCtrl + O
Flexible Sight Intensity Decrease	RAIt + O
Flexible Sight Intensity Increase	RCtrl + O
Flexible Sight Lamp Off	RCtrl + RShift + O
Flexible Sight Main Lamp	O
Flexible Sight On/Off	M
Flexible Sight Down	". "
Flexible Sight Left	". "
Flexible Sight Right	"/"
Flexible Sight Up	". "
Front Dash	
Altimeter Copilot, Pressure Decrease	LCtrl + B
Altimeter Copilot, Pressure Increase	LShift + B
Altimeter Pilot, Pressure Decrease	RCtrl + B
Altimeter Pilot, Pressure Increase	RShift + B
Attitude Indicator pilot, Pitch Decrease	LCtrl + N
Attitude Indicator pilot, Pitch Increase	LShift + N
Attitude Indicator pilot, Roll Decrease	LCtrl + M
Attitude Indicator pilot, Roll Increase	LShift + M

Clock Winding/Adjust	RShift + Q
Clock Winding/Adjust Decrease	RCtrl + 0
Clock Winding/Adjust Increase	RAlt + Q
Copilot Gyro Cage	RShift + G
Copilot Gyro, Pitch Decrease	RCtrl + F
Copilot Gyro, Pitch Increase	RShift + F
RadarAltimeter, Hight Altitude Decrease	RAlt + RShift + R
Radar Altimeter, Hight Altitude Increase	RCtrl + RWin + R
RadarAltimeter, Low Altitude Decrease	RAlt + RWin + R
RadarAltimeter, Low Altitude Increase	RShift + RWin + R
RadarAltimeter, Test	RAlt + R
General	
Briefing window	LAlt + B
Clickable mouse cockpit mode On/Off	LAlt + C
Debriefing window	RShift + '
End mission	Esc
Frame rate counter - Service info	RCtrl + Pause
Get New Plane - respawn	RCtrl + RShift + Tab
Info bar coordinate units toggle	LAlt + Y
Info bar toggle	LCtrl + Y
Jump into other aircraft	RAlt + J
Multiplayer chat - mode All	Tab
Multiplayer chat - mode Allies	LCtrl + Tab
Pause	Pause
Rearming and Refueling Window	LAlt + 1
Score window	I
Screenshot	SysRQ
Show controls indicator	RCtrl + Enter
Time accelerate	LCtrl + Z
Time decelerate	LAlt + Z
Time normal	LShift + Z
Gunners AI Panel	
AI Left Burst Switch	LShift + 3
AI Left ROE Iterate	LCtrl + 3
AI Operator Burst Switch	LShift + 2
AI Operator ROE Iterate	LCtrl + 2
AI Panel Show/Hide	LWin + H
AI Right Burst Switch	LShift + 4
AI Right ROE Iterate	LCtrl + 4
Ins Collective Stick	
Collective down	Nun -
Collective up	Num+
Decrease Turbine RPM	RCtrl + PageDown
Increase Turbine RPM	RCtrl + PageUp
Landing light Extend	RCtrl + /

Landing light On/Off	RCtrl +.
Landing light Retract	RWin +/
Landing light Stop	RAIt + /
Search light Extend	8
Search light Left	9
Search light Off	RAIt + ;
Search light On	RCtrl + ;
Search light Retract	7
Search light Right	0
Search light Stow	RWin + ;
Start-up engine	Home
Throttle Down	PageDown
Throttle Stop	RWin +T
Throttle Up	PageUp
Ins Cyclic Stick	
Co-pilot's radio trigger ICS	LShift + Space
Co-pilot's radio trigger RADIO	LCtrl + Space
Copilot weapon release	RAIt + Space
Cyclic bank left	Left
Cyclic bank right	Right
Cyclic nose down	Up
Cyclic nose up	Down
Pilot Trimmer	T
Pilot weapon release/Machinegun fire	Space
Pilot's radio trigger ICS	RShift + Space
Pilot's radio trigger RADIO	RAIt + \
Trimmer reset	LCtrl + T
Ins Overhead panel	
Anti Collision Light On/Off	RShift+ L
Battery ON/OFF	LShift + P
Copilot Instrument Light Decrease	LAlt + LWin + C
Copilot Instrument Light Increase	LCtrl + LWin + C
Dome Light Green	RAIt + RShift + L
Dome Light Off	RAIt + RShift + 0
Dome Light White	RAIt + RShift + P
Engine Instrument Light Decrease	LAlt + LWin + E
Engine Instrument Light Increase	LCtrl + LWin + E
Inverter MAIN ON	LShift + U
Inverter OFF	LShift + 1
Inverter SPARE ON	LShift + 0
Inverter switch	LShift + Y
Main generator ON/OFF	LShift + Q
Main generator RESET	LShift + A
Main generator cover	LShift + L
Nav Lights Dim/Bright	RAIt + L

Nav Lights Flash	RCtrl + RWin + L
Nav Lights Off	RCtrl + L
Nav Lights Steady	RAlt + RWin + L
Non-Ess Bus NORMAL ON/MANUAL ON	LShift + C
Overhead Console Light Decrease	LAlt + LWin + 0
Overhead Console Light Increase	LCtrl + LWin + 0
Pedestal Light Decrease	LAlt + LWin + P
Pedestal Light Increase	LCtrl + LWin + P
Pilot Instrument Light Decrease	LAlt + LCtrl + LWin + P
Pilot Instrument Light Increase	LCtrl + LShift + LWin + P
Pitot Heater	RAlt + P
Secondary Instrument Light Decrease	LAlt + LWin + S
Secondary Instrument Light Increase	LCtrl + LWin + S
Starter-Generator STARTER/STBY GEN	LShift + X
Voltmeter AC switch	LShift + W
Voltmeter AC, AB phase	LShift + E
Voltmeter AC, AC phase	LShift + R
Voltmeter AC, BC phase	LShift + T
Voltmeter DC switch	LShift + S
Voltmeter DC, BAT	LShift + D
Voltmeter DC, ESS BUS	LShift + H
Voltmeter DC, MAIN GEN	LShift + F
Voltmeter DC, NON-ESS BUS	LShift + J
Voltmeter DC, STBY GEN	LShift + G
Windshield Mode Decrease	RAlt + ,
Windshield Mode Increase	RAlt + .
Wiper Mode Selector Down	S
Wiper Mode Selector Up	W
Ins rudder	
Rudder left	Z
Rudder right	X
Intercom Control Panel	
Intercom Mode 1	RCtrl + RShift + R
Intercom Mode 2	RCtrl + RShift + T
Intercom Mode 3	RCtrl + RShift + Y
Intercom Mode 4	RCtrl + RShift + U
Intercom Mode INT	RCtrl + RShift + E
Intercom Mode PVT	RCtrl + RShift + W
Intercom Mode Selector (rotary)	RCtrl + RShift + Q
Intercom Receiver #1	RCtrl + RShift + 1
Intercom Receiver #2	RCtrl + RShift + 2
Intercom Receiver #3	RCtrl + RShift + 3
Intercom Receiver #4	RCtrl + RShift + 4
Intercom Receiver INT	RCtrl + RShift + 5
Intercom Receiver NAV	RCtrl + RShift + 6

Intercom Volume Decrease	RCtrl + RShift + -
Intercom Volume Increase	RCtrl + RShift + =
Kneeboard	
Kneeboard Next Page]
Kneeboard ON/OFF	RShift + K
Kneeboard Previous Page	[
Kneeboard current position mark point	RCtrl + K
Kneeboard glance view	K
Labels	
Aircraft Labels	LShift + F2
All Labels	LShift + F10
Missile Labels	LShift + F6
Vehicle & Ship Labels	LShift + F9
Main panel	
Fire Detector Test	RCtrl + T
Fuel Indicator Test	LAlt + LCtrl + LShift + P
Pedestal	
Armed lamp Test	
Caution Panel Dim Switch Bright	LAlt + F
Caution Panel Dim Switch Dim	LCtrl + F
Caution Panel Test/Reset Switch Reset	R
Caution Panel Test/Reset Switch Test	LAlt + R
De-Ice On/Off	I
Flare Dispense	LCtrl + C
Governor Auto/Emer	G
Low RPM Warning	RCtrl + W
MAN/PGRM Mode	
Main Fuel Switch	F
Ripple Fire	
Ripple Fire Cover	
SAFE/ARMED Switcher	
Pilot Sight	
Pilot Sight Armed/Docked	RShift + M
Pilot Sight Elevation Decrease	LAlt + S
Pilot Sight Elevation Increase	LCtrl + S
Pilot Sight Intensity Decrease	LAlt + X
Pilot Sight Intensity Increase	LCtrl + X
Pilot Sight On/Off	RCtrl + M
Radio Communications	
Attack my target	LWin + Q
Communication menu	\
Cover me	LWin + W
Flight - Attack air defenses	LWin + D
Flight - Attack ground targets	LWin + G
Flight - Complete mission and RTB	LWin + E

Join up formation	LWin + Y
Switch dialog	LShift + \
Sensors	
Night Vision Goggles	RShift + H
Night Vision Goggles Gain Down	RAlt + RShift + H
Night Vision Goggles Gain Up	RCtrl + RShift + H
Systems	
Chip detectorTAIL ROTOR	LWin + B
Chip detector XMSN	LAlt + T
Cockpit door open/dose	RCtrl + C
Course Indicator OBS Decrease	LCtrl + .
Course Indicator OBS Increase	LCtrl + ,
Force Trim System On/Off	LAlt + U
GMC Manual Heading Decrease	LCtrl + LShift + .
GMC Manual Heading Increase	LCtrl + LShift + ,
GMC Operating Mode Slave/Gyro	LAlt + LCtrl + G
GMC Pointer #1ADF/VOR	LCtrl + G
GMC Synchronizing +	LAlt + LCtrl + ,
GMC Synchronizing o	LAlt + LCtrl + .
Hydraulic control On/Off	LAlt + 1
Leave Helicopter (3 times)	LCtrl + E
Marker Beacon Sensitivity High/Low	LShift + V
Marker Beacon Volume Decrease	LShift + .
Marker Beacon Volume Increase	LShift + ;
UHF Radio Control panel	
UHF Preset Channel Decrease	LCtrl + LShift + A
UHF Preset Channel Increase	LCtrl + LShift + S
UHF Radio 10MHz Decrease	LCtrl + LShift + W
UHF Radio 10MHz Increase	LCtrl + LShift + E
UHF Radio 1MHz Decrease	LCtrl + LShift + R
UHF Radio 1MHz Increase	LCtrl + LShift + T
UHF Radio 50kHz Decrease	LCtrl + LShift + Y
UHF Radio 50kHz Increase	LCtrl + LShift + U
UHF Radio Freq. Mode GD XMIT	LCtrl + LShift + 8
UHF Radio Freq. Mode MAN	LCtrl + LShift + 7
UHF Radio Freq. Mode PRESET	LCtrl + LShift + 6
UHF Radio Freq. Mode Select(rotary)	LCtrl + LShift + 5
UHF Radio Mode ADF	LCtrl + LShift + 4
UHF Radio Mode OFF	LCtrl + LShift + 1
UHF Radio Mode Select(rotary)	LCtrl + LShift + '
UHF Radio ModeT/R	LCtrl + LShift + 2
UHF Radio ModeT/R+G	LCtrl + LShift + 3
UHF Radio Squelch On/Off	LCtrl + LShift + Q
UHF Radio Volume Decrease	LCtrl + LShift + ;

UHF Radio Volume Increase	LCtrl + LShift + '
VHF AM Radio Control panel	
VHF AM Radio Freq. MHz Decrease	LCtrl + LShift + 0
VHF AM Radio Freq. MHz Increase	LCtrl + LShift + P
VHF AM Radio Freq. kHz Decrease	LCtrl + LShift + [
VHF AM Radio Freq. kHz Increase	LCtrl + LShift +]
VHF AM Radio Power ON/OFF	LCtrl + LShift + 9
VHF AM Radio Test	LCtrl + LShift + I
VHF AM Radio Volume Decrease	LCtrl + LShift + -
VHF AM Radio Volume Increase	LCtrl + LShift + =
VHF FM Radio Control panel	
VHF FM Radio 100kHz Decrease	RAIt + RCtrl + T
VHF FM Radio 100kHz Increase	RAIt + RCtrl + Y
VHF FM Radio 10MHz Decrease	RAIt + RCtrl + 0
VHF FM Radio 10MHz Increase	RAIt + RCtrl + W
VHF FM Radio 1MHz Decrease	RAIt + RCtrl + E
VHF FM Radio 1MHz Increase	RAIt + RCtrl + R
VHF FM Radio 50kHz Decrease	RAIt + RCtrl + U
VHF FM Radio 50kHz Increase	RAIt + RCtrl + I
VHF FM Radio Mode HOME	RAIt + RCtrl + 4
VHF FM Radio Mode OFF	RAIt + RCtrl + 1
VHF FM Radio Mode RETRAN	RAIt + RCtrl + 3
VHF FM Radio Mode Select (rotary)	RAIt + RCtrl + '
VHF FM Radio ModeTR	RAIt + RCtrl + 2
VHF FM Radio Squelch CARR	RAIt + RCtrl + 7
VHF FM Radio Squelch DIS	RAIt + RCtrl + 6
VHF FM Radio Squelch Select (rotary)	RAIt + RCtrl + 5
VHF FM Radio Squelch TONE	RAIt + RCtrl + 8
VHF FM Radio Volume Decrease	RAIt + RCtrl + -
VHF FM Radio Volume Increase	RAIt + RCtrl + =
VOR/ILS Control panel	
VOR/ILS Freq. MHz Decrease	LAlt + LShift + 0
VOR/ILS Freq. MHz Increase	LAlt + LShift + P
VOR/ILS Freq. kHz Decrease	LAlt + LShift + [
VOR/ILS Freq. kHz Increase	LAlt + LShift +]
VOR/ILS Mode Select (rotary)	LAlt + LShift + '
VOR/ILS Power OFF	LAlt + LShift + 1
VOR/ILS Power PWR	LAlt + LShift + 2
VOR/ILS Power TEST	LAlt + LShift + 3
VOR/ILS Volume Decrease	LAlt + LShift + -
VOR/ILS Volume Increase	LAlt + LShift + =
View	
Camera view keyboard rate fast	LShift +]
Camera view keyboard rate normal	LAlt +]
Camera view keyboard rate slow	LCtrl +]

Camera view mouse rate fast	LShift + [
Camera view mouse rate normal	LAlt + [
Camera view mouse rate slow	LCtrl + [
CenterView	Num5
F1 Cockpit view	F1
F1 HUD only view switch	LAlt + F1
F1 Natural head movement view	LCtrl + F1
F10 Jump to theater map view over current point	LCtrl + F10
F10 Theater map view	F10
F11 Airport free camera	F11
F11 Jump to free camera	LCtrl + F11
F11 camera moving backward	LAlt + Num/
F11 camera moving forward	LAlt + Num*
F12 Civil traffic view	LCtrl + F12
F12 Static object view	F12
F12 Trains/cars toggle	LShift + F12
F2 Aircraft view	F2
F2 Toggle camera position	RAlt + F2
F2 Toggle local camera control	LAlt + F2
F2 View own aircraft	LCtrl + F2
F3 Fly-By jump view	LCtrl + F3
F3 Fly-By view	F3
F4 Arcade Chase view	LShift + F4
F4 Chase view	LCtrl + F4
F4 Look back view	F4
F5 Ground hostile view	LCtrl + F5
F5 Nearest AC view	F5
F6 Released weapon view	F6
F6 Weapon to target view	LCtrl + F6
F7 Ground unit view	F7
F8 Player targets/All targets filter	RAlt + F8
F8 Target view	F8
F9 Landing signal officer view	LAlt + F9
F9 Ship view	F9
Object exclude	LAlt + Delete
Objects all excluded - include	LAlt + Insert
Objects switching direction forward	LCtrl + PageDown
Objects switching direction reverse	LCtrl + PageUp
View Down Left slow	Num1
View Down Right slow	Num3
View Down slow	Num2
View Left slow	Num4
View Right slow	Num6
View Up Left slow	Num7
View Up Right slow	Num9

View Up slow	Num8
Zoom external in	RCtrl + Num*
Zoom external normal	RCtrl + NumEnter
Zoom external out	RCtrl + Num /
Zoom in slow	Num*
Zoom normal	NumEnter
Zoom out slow	Num/
View Cockpit	
Camera transpose mode (press and hold)	LShift + F1
Camera view down	RCtrl + Num2
Camera view down slow	RAIt + Num2
Camera view down-left	RCtrl + Num1
Camera view down-left slow	RAIt + Num1
Camera view down-right	RCtrl + Num3
Camera view down-right slow	RAIt + Num3
Camera view left	RCtrl + Num4
Camera view left slow	RAIt + Num4
Camera view right	RCtrl + Num6
Camera view right slow	RAIt + Num6
Camera view up	RCtrl + Num8
Camera view up slow	RAIt + Num8
Camera view up-left	RCtrl + Num7
Camera view up-left slow	RAIt + Num7
Camera view up-right	RCtrl + Num9
Camera view up-right slow	RAIt + Num9
Center camera view	RShift + Num5
Cockpit Camera Move Back	RCtrl + RShift + Num/; R
Cockpit Camera Move Center	RCtrl + RShift + Num5
Cockpit Camera Move Down	RCtrl + RShift + Num2
Cockpit Camera Move Forward	RCtrl + RShift + Num*
Cockpit Camera Move Left	RCtrl + RShift + Num4
Cockpit Camera Move Right	RCtrl + RShift + Num6
Cockpit Camera Move Up	RCtrl + RShift + Num8
Cockpit panel view in	Num0
Cockpit panel view toggle	RCtrl + Num0
Enable visual recon mode	
Head shift movement on / off	LWin + F1
Return camera	RCtrl + Num5
Return camera base	RAIt + Num5
Save Cockpit Angles	RAIt + Num0
Set Left Gunner Seat	3
Set Operator Seat	2
Set Pilot Seat	1
Set Right Gunner Seat	4
Snap View 0	LWin + Num0

Snap View 1	LWin + Num1
Snap View 2	LWin + Num2
Snap View 3	LWin + Num3
Snap View 4	LWin + Num4
Snap View 5	LWin + Num5
Snap View 6	LWin + Num6
Snap View 7	LWin + Num7
Snap View 8	LWin + Num8
Snap View 9	LWin + Num9
View down	RShift + Num2
View down left	RShift + Num1
View down right	RShift + Num3
View left	RShift + Num4
View right	RShift + Num6
View up	RShift + Num8
View up left	RShift + Num7
View up right	RShift + Num9
Zoom in	RShift + Num*
Zoom out	RShift + Num/
View Extended	
Camera jiggle toggle	LShift + J
Keep terrain camera altitude	LAlt + K
Toggle tracking fire weapon	RCtrl + Num+
View all mode	RAlt + RCtrl + RShift + A
View enemies mode	RAlt + RCtrl + RShift + D
View friends mode	RAlt + RCtrl + RShift + F
View Padlock	
All missiles padlock	RShift + Num.
Lock terrain view	RCtrl + Num.
Lock view (cycle padlock)	Num.
Threat missile padlock	RAlt + Num.
Unlock view (stop padlock)	NumLock



14

ABBREVIATIONS
& TERMS

14. ABBREVIATIONS AND TERMS

AC	Alternating Current	COMPT	Compartment
ADF	Automatic Direction Finder	CONT	Control
AGL	Above Ground Level	CONT	Continuous
AI	Attack Imminent	CONV	Converter
ALT	Alternator	CW	Clockwise
ALT	Altitude/Altimeter	DC	Direct Current
ALTM	Altimeter	DCP	Dispenser Control Panel
AM	Amplitude Modulation	DF	Direction Finding
AMP	Ampere	DECR	Decrease
ANT	Antenna	DELTA A	Incremental Change
ATTD	Attitude	DET	Detector
AUTO	Automatic	DG	Directional Gyro
AUX	Auxiliary	DIS	Disable
AVGAS	Aviation Gasoline	DISP	Dispense
BAT	Battery	DSCRM	Discriminator
BDHI	Bearing Distance Heading Indicator	ECM	Electronic Countermeasures
BFO	Beat Frequency Oscillator (to 7.2.2)	EGT	Exhaust Gas Temperature
BL	Butt Line	ELEC	Electrical
BRIL	Brilliance	EMER	Emergency
BRT	Bright	END	Endurance
C	Celsius	ENG	Engine
CARR	Carrier	ESS	Essential
CAS	Calibrated Airspeed	EXH	Exhaust
CCW	Counter Clockwise	EXT	Extend
CDI	Course Deviation Indicator	EXT	Exterior
CG	Center of Gravity	F	Fahrenheit
CL	Centerline	FAT	Free Air Temperature
CMPS	Compass	FITG	Fitting
CNVTR	Converter	FCU	Fuel Control Unit
COLL	Collision	FM	Frequency Modulation
COMM	Communication	FOD	Foreign Object Damage
		FPS	Feet Per Second



	FREQ Frequency
--	----------------

FS	Fuselage Station	INVTR	Inverter
FT	Foot	IR	Infrared
FT/MIN	Feet Per Minute	IRT	Indicator Receiver Transmitter
FUS	Fuselage	ISA	International Standard Atmosphere
FWD	Forward	KCAS	Knots Calibrated Airspeed
ΔF	Increment of Equivalent Flat Plate Drag Area	kHz	Kilohertz
G	Gravity	KIAS	Knots Indicated Airspeed
G	Guard	km	Kilometer
GAL	Gallon	KTAS	Knots True Airspeed
GD	Guard	KN	Knots
GEN	Generator	kVA	Kilovolt-Ampere
GND	Ground	kW	Kilowatt
GOV	Governor	L	Left
GPU	Ground Power Unit	LB	Pounds
GRWT	Gross Weight	LDG	Landing
GW	Gross Weight	LH	Left Hand
HDG	Heading	LSB	Lower Sideband
HF	High Frequency	LT	Lights
HIT	Health Indicator Test	LTG	Lighting
HTR	Heater	LTS	Lights
HYD	Hydraulic	MAG	Magnetic
IAS	Indicated Airspeed	MAN	Manual
ICS	Interphone Control Station	MAX	Maximum
IDENT	Identification	MED	Medium
IFF	Identification Friend or Foe	MHF	Medium-High Frequency
IGE	In Ground Effect	MHz	Megahertz
IN	Inch	MIC	Microphone
INCR	Increase	MIN	Minimum
IND	Indication/Indicator	MIN	Minute
INHG	Inches of Mercury	MISC	Miscellaneous

INOP Inoperative	mm Millimeter
INST Instrument	MON Monitor
INT Internal	MWO Modification Work Order
INT Interphone	NAV Navigation
INV Inverter	NET Network

NO Number	SEC Secure
NM Nautical Mile	SEL Select
NON-ESS Non-Essential	SENS Sensitivity
NON-SEC Non-Secure	SL Searchlight
NORM Normal	SOL Solenoid
NVG Night Vision Goggles	SQ Squelch
NR Gas Turbine Speed	SSB Single Sideband
N1 Gas Turbine Speed	STA Station
N2 Power Turbine Speed	STBY Standby
OGE Out of Ground Effect	SQ FT Square Feet
PED Pedestal	TAS True Airspeed
PLT Pilot	TEMP Temperature
PRESS Pressure	TGT Turbine Gas Temperature
PRGM Program	T/R Transmit-Receive
PSI Pounds Per Square Inch	TRANS Transfer
PVT Private	TRANS Transformer
PWR Power	TRANS Transmitter
QTY Quantity	TRQ Torque
%Q Percent Torque	UHF Ultra-High Frequency
R Right	USB Upper Sideband
RCVR Receiver	VAC Volts, Alternating Current
R/C Rate of Climb	VDC Volts, Direct Current
R/D Rate of Descent	VHF Very high Frequency
RDR Radar	VM Volt Meter
RDS Rounds	VOL Volume
REL Release	VOR VHF Omni Directional Range
REM Remote	VNE Velocity, Never Exceed (Airspeed Limitation)
RETR Retract	



RETRAN	Retransmission	WL	Water line
RF	Radio Frequency	WPN	Weapon
RH	Right Hand	XCVR	Transceiver
RI	Remote Height Indicator	XMIT	Transmit
RPM	Revolutions Per Minute	XMTR	Transmitter
SAM	Surface to Air Missile	XMSN	Transmission
SEC	Secondary		



15

THE METRIC
SYSTEM & EQUIVALENTS,
CONVERSION FACTORES

15. THE METRIC SYSTEM AND EQUIVALENTS, CONVERSION FACTORS

15.1.1. The Metric System and Equivalents

Linear Measure

1 centimeter = 10 millimeters = .39 inch
 1 decimeter = 10 centimeters = 3.94 inches
 1 meter = 10 decimeters = 39.37 inches
 1 dekameter = 10 meters = 32.8 feet
 1 hectometer = 10 dekameters = 328.08 feet
 1 kilometer = 10 hectometers = 3,280.8 feet

Weights

1 centigram = 10 milligrams = .15 grain
 1 decigram = 10 centigrams = 1.54 grains
 1 gram = 10 decigram = .035 ounce
 1 decagram = 10 grams = .35 ounce
 1 hectogram = 10 decagrams = 3.52 ounces
 1 kilogram = 10 hectograms = 2.2 pounds
 1 quintal = 100 kilograms = 220.46 pounds
 1 metric ton = 10 quintals = 1.1 short tons

Liquid Measure

1 centiliter = 10 milliliters = .34 fl. ounce
 1 deciliter = 10 centiliters = 3.38 fl. ounces
 1 liter = 10 deciliters = 33.81 fl. ounces
 1 dekaliter = 10 liters = 2.64 gallons
 1 hectoliter = 10 dekaliters = 26.42 gallons
 1 kiloliter = 10 hectoliters = 264.18 gallons

Square Measure

1 sq. centimeter = 100 sq. millimeters = .155 sq. inch
 1 sq. decimeter = 100 sq. centimeters = 15.5 sq. inches
 1 sq. meter (centare) = 100 sq. decimeters = 10.76 sq. feet
 1 sq. dekameter (are) = 100 sq. meters = 1,076.4 sq. feet
 1 sq. hectometer (hectare) = 100 sq. dekameters = 2.47 acres
 1 sq. kilometer = 100 sq. hectometers = .386 sq. mile

Cubic Measure

1 cu. centimeter = 1000 cu. millimeters = .06 cu. inch
 1 cu. decimeter = 1000 cu. centimeters = 61.02 cu. inches
 1 cu. meter = 1000 cu. decimeters = 35.31 cu. feet

15.1.2. Approximate Conversion Factors

To change	To	Multiply by
(imperial)	(metric)	
inches	centimeters	2.540
feet	meters	.305
yards	meters	.914
miles	kilometers	1.609
knots	km/h	1.852
square inches	square centimeters	6.451
square feet	square meters	.093
square yards	square meters	.836
square miles	square kilometers	2.590
acres	square hectometers	.405
cubic feet	cubic meters	.028
cubic yards	cubic meters	.765
fluid ounces	milliliters	29,573
pints	liters	.473
quarts	liters	.946
gallons	liters	3.785
ounces	grams	28.349
pounds	kilograms	.454
short tons	metric tons	.907
pound-feet	Newton-meters	1.356
pound-inches	Newton-meters	.11296
ounce-inches	Newton-meters	.007062
(metric)	(imperial)	
centimeters	inches	.394
meters	feet	3.280
meters	yards	1.094
kilometers	miles	.621
km/h	knots	0.54
square centimeters	square inches	.155
square meters	square feet	10.764
square meters	square yards	1.196
square kilometers	square miles	.386
square hectometers	acres	2.471
cubic meters	cubic feet	35.315
cubic meters	cubic yards	1.308
milliliters	fluid ounces	.034
liters	pints	2.113
liters	quarts	1.057
liters	gallons	.264
grams	ounces	.035
kilograms	pounds	2.205
metric tons	short tons	1.102

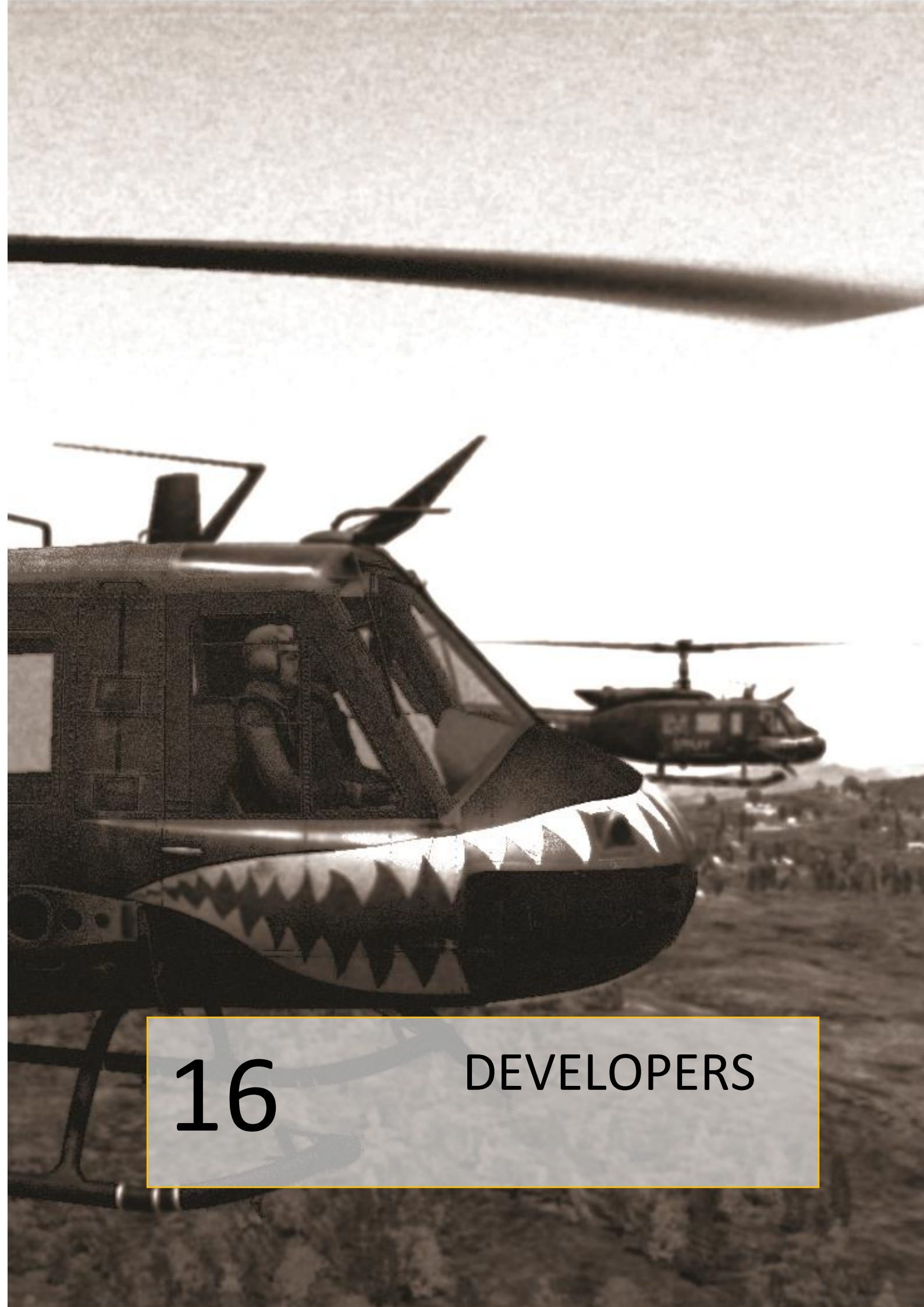

16

DEVELOPERS

16. DEVELOPERS

BELSIMTEK

MANAGEMENT

Alexander Podvoyskiy	Project and QA Manager, technical documentation
----------------------	--

PROGRAMMERS

Andrey Kovalenko	Administration, avionics, weapons, damage model
------------------	--

Nikolay Volodin	Flight dynamics, damage model
-----------------	----------------------------------

Vladimir Mikhailov	Engine and related system, game autopilot
--------------------	--

Boris Silakov	Systems of helicopter, game autopilot
---------------	--

Alexander Mishkovich	Systems of helicopter
----------------------	-----------------------

Evgeny Gribovich	Systems of helicopter, avionics, effects
------------------	---

Konstantin Kuznetsov "btd"	Sound Developer, Music Composer
----------------------------	------------------------------------

DESIGNERS

Evgeny Khigniak	3D-model of helicopter, cockpit, damage model
-----------------	--

Andrey Reshetko	Pilots and gunners
-----------------	--------------------

Stanislav Kolesnikov	Cockpit
----------------------	---------

SCIENCE SUPPORT

Sergey "Vladimirovich"	Mathematic model of dynamics
------------------------	------------------------------

TESTER STAFF

Dmitry "Laivynas" Koshelev

Gavin "159th_Viper" Torr

Gene "EvilBivol-1" Bivol

"graywo1fg"

"Frogfoot"

"joyride"

"HuggyBear"

"luckybob"

Matt "Wags" Wagner

"paulkriiii"

Peter "Weta43" McAllister

Roberto "Vibora" Seoane Penas

Norm "SiThSpAwN" Loewen

"shadowoweosa"

Stephen "Nate--IRL--" Barrett

Tyler "Krebs20" Krebs

Werner "derelor" Siedenburg

"weta43"

"Furia"

IT AND CUSTOMER SUPPORT

MISSION AND CAMPAIGNS

Oleg "Dzen" Fedorenko, Dmitry "Laivynas" Koshelev

ARTISTS AND SOUND

Vibora, graywo1fg, SithSpawn, luckybob, paulkriiii, EvilBivol-1, joyride, Wags, derelor, weta43, Curtis Brown, Walter Duccini

TRAINING

Gene "EvilBivol-1" Bivol

Training missions, technical documentation, support Forum

THIRD PARTIES

Dillon Aero (www.dillonaero.com): UH-1 support (live - video / audio). Dillon designs, develops, manufactures, and supports the M134D Gatling Gun and related products for air, land and sea applications. The company's growing product line includes high-capacity feed systems for the M134D and M240, weapon mounts, and safety and support equipment for the Gatling Gun.

American Huey 369 (www.americanhuey369.com): UH-1 support (live - video / audio / Rocket and Minigun systems). American Huey 369 was formed for the purpose of preserving the legendary UH-1 Huey in honor and tribute to all U.S. Military Veterans & Patriots and for educating future generations on the Vietnam War's most iconic aircraft.

Anthony Thigpen – UH-1 live audio recording (student - Collins College).

Richard Newsome – UH-1 live audio recording (student - Collins College).

Valerie Rubio – UH-1 live audio recording (student - Collins College).

Rick Fowler – UH-1 live audio recording supervisor (instructor - Collins College).

Jon Lemond – coordination (instructor - Collins College).

Roger Arias (www.worldatplay.com): Subject Matter Expert (former Army Aviator), Business / Product Development - Game Industry (Licensing – Textron / Bell Helicopter, UH-1 on-site permissions / live access).

SPECIAL THANKS TO

Tyler "Krebs20" Krebs		for a quick and professional assistance with technical issues, photos and videos
Werner Siedenburg	"derelor"	for scrupulous and professional work on editing the flight manual
Raul "Furia" Ortiz de Urbina		for a dedicated and heartfelt effort in testing the flight model and helping to ensure its high level of quality is achieved
Norm "SiThSpAwN" Loewen		for improving layout and formatting



17

BIBLIOGRAPHY
& SOURCES

17. BIBLIOGRAPHY AND SOURCES

- A mathematical force and moment model of a UH-1H helicopter for flight dynamics simulations. NASA technical memorandum TM-73,254 (Revised 8/30/78). Peter D.Talbot and Lloyd D.Corriss. Ames Research Center NASA and Ames Directorate, USAAMRDL, AVRADCOM Ames Research Center Moffett Field, Calif. 94035. June 1977
- Army Field Manual FM 1-203, Fundamentals Of Flight
- Chickenhawk. Robert Mason. PENGUIN BOOKS. Copyright © Robert C. Mason, 1983 All rights reserved
- Field manual FM 1-100. Army aviation operations. Headquarters Department of the Army, Washington, DC, 21 february 1997
- Field Manual FM 1-113. Utility and cargo helicopter operations. Headquarters Department of the Army, Washington, DC, 12 September 1997
- TM 55-1520-210-10 (1988_0215+ch19 2002_1231) OPERATOR'S MANUAL. ARMY MODEL UH-1H/V HELICOPTERS. December 1986, including all changes. HEADQUARTERS, DEPARTMENT OF THE ARMY. 15 FEBRUARY 1988
- TM 55-1520-210-23-1 (1987_0930+ch47 2005_0920) AVIATION UNIT AND INTERMEDIATE. MAINTENANCE INSTRUCTIONS ARMY MODEL UH-1H/V/EH-1H/X HELICOPTERS. February 1979, including all changes. HEADQUARTERS, DEPARTMENT OF THE ARMY. 30 SEPTEMBER 1987
- UH-1 HUEY in action. By Wayne Mutza. Copyright 1986 squadron/signal publications, inc. 1115 Crowley drive, Carrollton, Texas 75011-5010
- US Army Aviation Logistics School: HELICOPTER FUNDAMENTALS
- Гессоу А., Мейерс Г. Аэродинамика вертолета. Перевод Бирюлина В. Под редакцией Братухина И. – М.: Государственное издательство оборонной промышленности. 1954.
- Загордан А. Элементарная теория вертолета. – М.: Военное Издательство Министерства Обороны Союза ССР. 1955.

